

S W I S S  
C A D

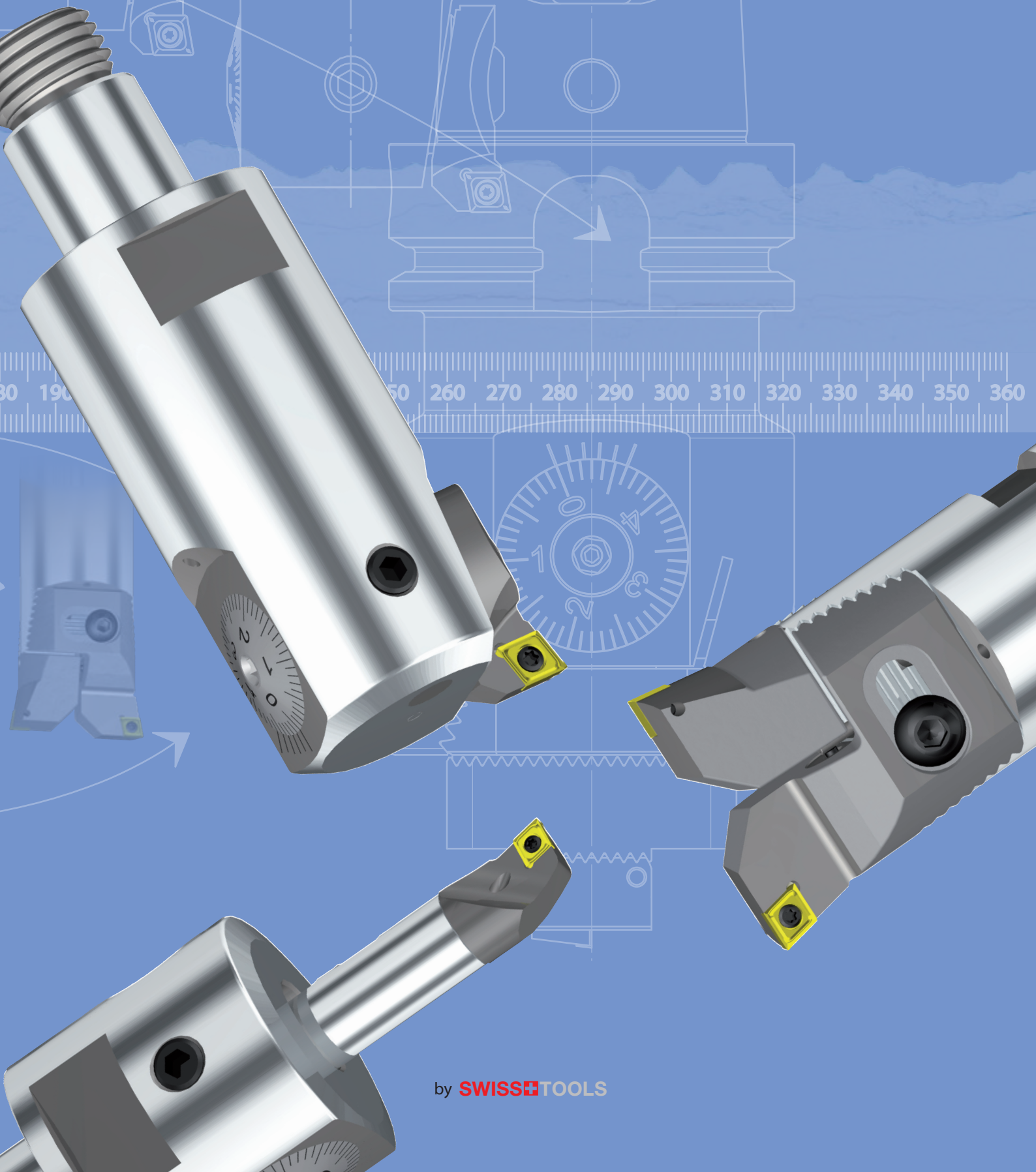

by **SWISS**TOOLS

Seite / page 5

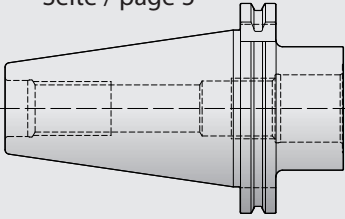

Seite / page 5

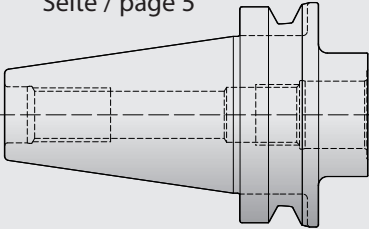

Seite / page 5

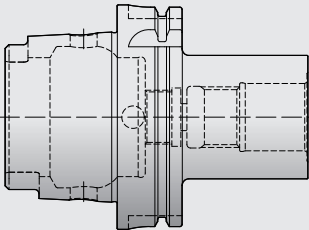

Seite / page 6

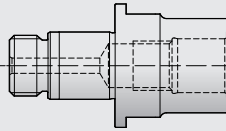

Seite / page 6

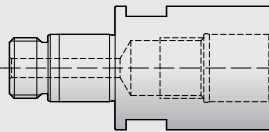

Seite / page 11

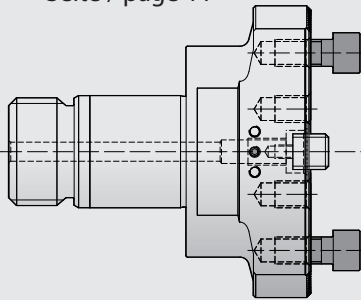

Seite / page 11

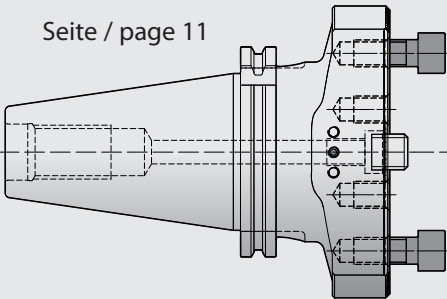

Seite / page 11

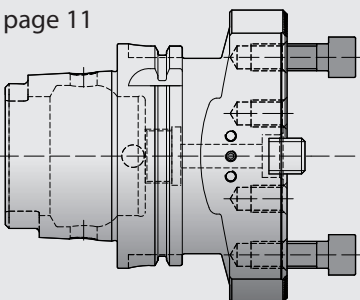

Seite / page 8

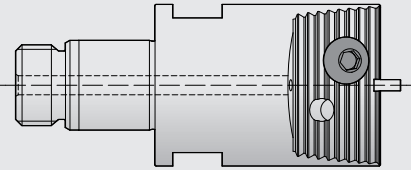

Seite / page 7

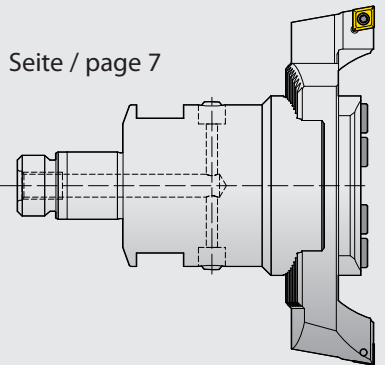

Seite / page 12

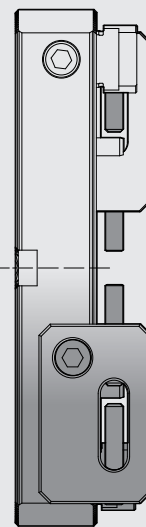

Seite / page 13

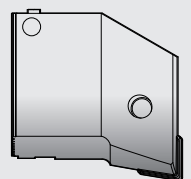
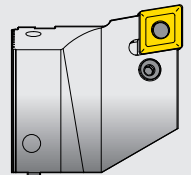



Seite / page 30 + 31

Seite / page 22

Seite / page 21

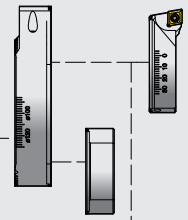
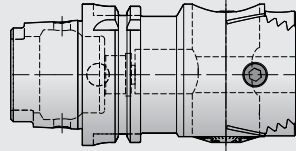

Seite / page 23

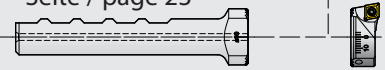

Seite / page 23

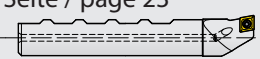

Seite / page 24



Seite / page 25



Seite / page 27

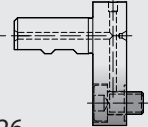

Seite / page 26



Seite / page 20



Seite / page 20

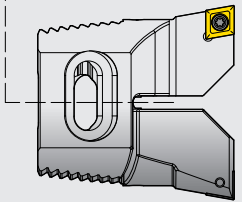
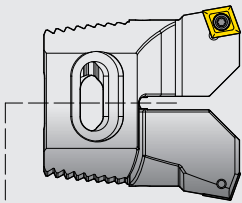
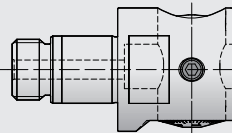

Seite / page 9 + 10

Seite / page 17+18

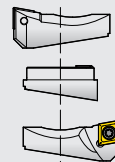

Seite / page 16

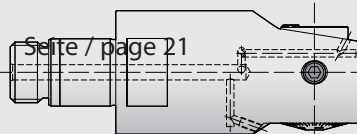

Seite / page 13

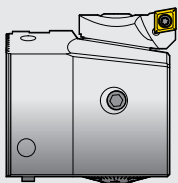

Seite / page 19

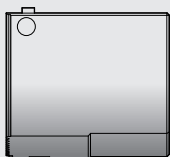
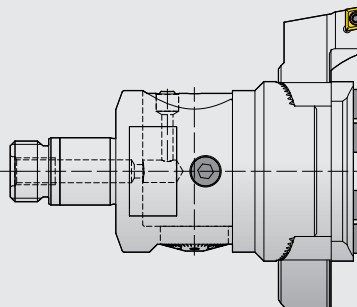

### Spannsystem CAD

Durch die zentrale Schraubverbindung wird der Zapfen in die Aufnahme gezogen. Das zentrale Gewinde erlaubt eine verzugfreie Verbindung. Dank grosser Auflageflächen und hoher Vorspannung wird eine sehr grosse Steifigkeit erzielt.

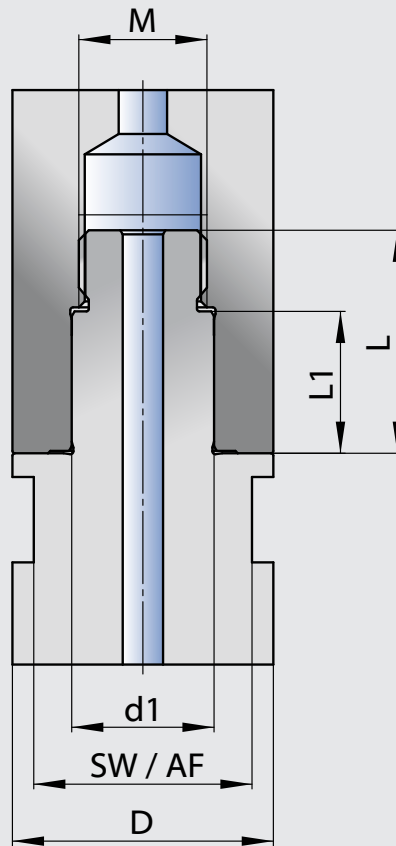

### quick-change coupling system CAD

The male pilot will be clamped into the female receptacle by the central screw thread. The central thread ensures a connection without distortion. A very high rigidity is achieved by a big contact surface and high prestress.

#### Dimensionen

#### Dimensions

CAD	D	d1	L1	L	M	SW / AF
CAD 20	20	11	10	18	M10x0.75	17
CAD 25	25	14	14	24	M12x1.75	22
CAD 32	32	18	18	31	M16x2	27
CAD 42	42	24	24	39	M22x2.5	36
CAD 55	55	30	30	47	M27x3	46
CAD 72	72	40	40	62	M36x4	60
CAD 94	94	50	50	79	M48x5	80

Aufnahmen DIN 69893

Master shanks to DIN 69893

100

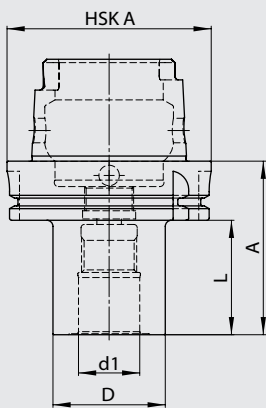

Bestell-Nr. / Order number	HSK A	D	d1	A	L
100.063.201	63	20	11	60	34
100.063.251	63	25	14	60	34
100.063.321	63	32	18	70	44
100.063.421	63	42	24	70	44
100.063.551	63	55	30	80	54
100.063.721	63	72	40	95	69
100.100.551	100	55	30	85	56
100.100.721	100	72	40	100	71
100.100.941	100	94	50	120	91

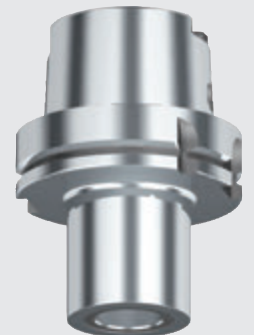

Aufnahmen MAS-BT «A/D»

Master shanks to MAS-BT «A/D»

100

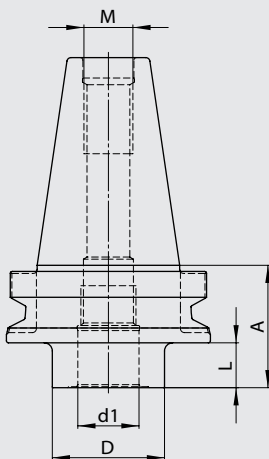

Bestell-Nr. / Order number	BT	D	d1	A	L	M
100.412.201	40	20	11	47	20	M 16
100.412.251	40	25	14	47	20	M 16
100.412.321	40	32	18	47	20	M 16
100.412.421	40	42	24	49	22	M 16
100.412.551	40	55	30	49	22	M 16
100.412.721	40	72	40	59	32	M 16
100.512.551	50	55	30	60	22	M 24
100.512.721	50	72	40	70	32	M 24
100.512.941	50	94	50	70	32	M 24



Aufnahmen DIN 69871 A/D

Master shanks to DIN 69871 A/D

100

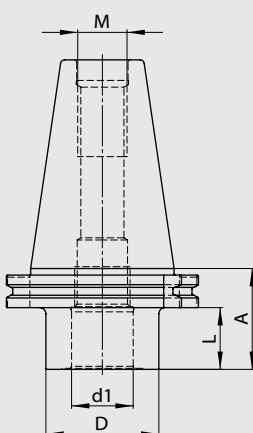

Bestell-Nr. / Order number	ISO	D	d1	A	L	M
100.415.201	40	20	11	34.1	15	M 16
100.415.251	40	25	14	44.1	25	M 16
100.415.321	40	32	18	44.1	25	M 16
100.415.421	40	42	24	49.1	30	M 16
100.415.551	40	55	30	49.1	30	M 16
100.415.721	40	72	40	59.1	40	M 16
100.515.551	50	55	30	49.1	30	M 24
100.515.721	50	72	40	59.1	40	M 24
100.515.941	50	94	50	66.1	47	M 24



120

Reduktionen

Reductions



Bestell-Nr. / Order number	D	d1	D2	d3	L1	L	SW / AF
120.250.201	25	14	20	11	15	30	22
120.320.201	32	18	20	11	15	30	27
120.320.251	32	18	25	14	25	40	27
120.420.201	42	24	20	11	15	35	36
120.420.251	42	24	25	14	25	45	36
120.420.321	42	24	32	18	25	45	36
120.550.201	55	30	20	11	15	35	46
120.550.251	55	30	25	14	20	40	46
120.550.321	55	30	32	18	25	45	46
120.550.421	55	30	42	24	30	50	46
120.720.321	72	40	32	18	25	55	60
120.720.421	72	40	42	24	30	60	60
120.720.551	72	40	55	30	30	60	60
120.940.421	94	50	42	24	30	65	75
120.940.551	94	50	55	30	30	65	75
120.940.721	94	50	72	40	45	80	75

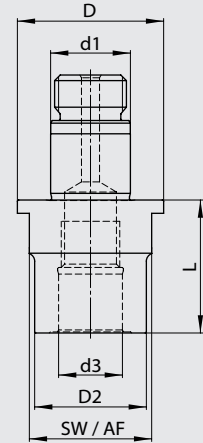

130

Verlängerungen

Extensions



Bestell-Nr. / Order number	D	d1	L	SW / AF
130.200.001	20	11	25	17
130.200.002	20	11	35	17
130.250.001	25	14	30	22
130.250.002	25	14	45	22
130.320.001	32	18	40	27
130.320.002	32	18	60	27
130.420.001	42	24	50	36
130.420.002	42	24	80	36
130.550.001	55	30	70	46
130.550.002	55	30	105	46
130.720.001	72	40	75	60
130.720.002	72	40	135	60
130.940.001	94	50	100	75
130.940.002	94	50	180	75

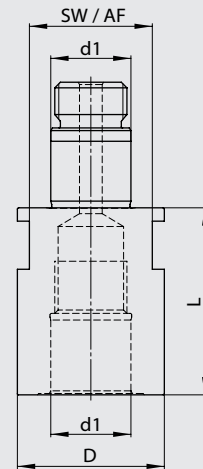

109

Ringnut-Bolzen für DIN 2080

Draw bolt for DIN 2080

- Anstelle von Aufnahmen nach DIN 2080 können Aufnahmen nach DIN 69871 mit den entsprechenden Ringnut-Bolzen verwendet werden

- Instead of using DIN 2080 adapters, the DIN 69871 shanks may be used with the corresponding draw bolt



Bestell-Nr. / Order number	ISO	M
109.400.000	40	M 16
109.500.000	50	M 24

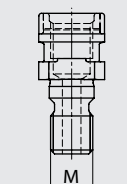

Zweischneiderkopf ø86-402

Twin cutter boring head ø86-402

144

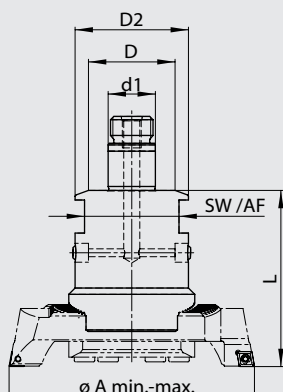

• mit Innenkühlung

• with inner coolant supply

Bestell-Nr. / Order number	D	d1	D2	ø A min.	ø A max.	L	SW / AF
144.550.000	55	30	72	86	402	112	60

• Wendeplattenhalter der Serie 147 müs-  
sen separat bestellt werden

• insert holders from serie 147 must be  
ordered separately

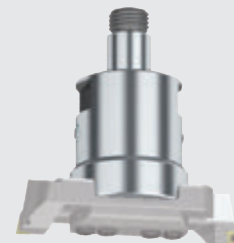

Wendeplattenhalterpaare  
inkl. Druckplatte

Insert holder pairs  
incl. clamp plate

147

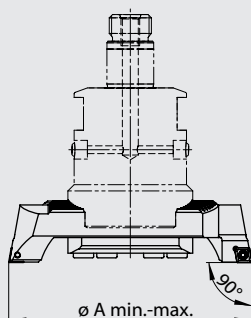

Bestell-Nr. / Order number	ø A min.	ø A max.	Wendeplatte / Insert
147.550.109	86	138	CC.. 09 T3 ..
147.550.112	86	138	CC.. 12 04 ..
147.550.209	136	220	CC.. 09 T3 ..
147.550.212	136	220	CC.. 12 04 ..
147.550.309	188	302	CC.. 09 T3 ..
147.550.409	242	402	CC.. 09 T3 ..



Ersatzteile / Zubehör

Spare parts / Accessories

144/147

Für Zweischneiderkopf For twin cutter boring head	Bestell-Nr. / Order number			
	Befestigungsschraube / Fastening screw ①			
144.550.000	850.144.550			
Für Wendeplatten- haltersatz For insert holder set	Bestell-Nr. / Order number	Bestell-Nr. / Order number	Bestell-Nr. / Order number	Bestell-Nr. / Order number
	Wendeplattenhal- ter / Insert holder ②	Druckplatte / Clamp plate ③	Torx-Schraube / Torx screw ④	Torx-Schlüssel / Torx driver
147.550.109	190.550.109	884.190.109	843.009.000	842.009.000
147.550.112	190.550.112	884.190.109	843.012.000	842.012.000
147.550.209	190.550.209	884.190.209	843.009.000	842.009.000
147.550.212	190.550.212	884.190.209	843.012.000	842.012.000
147.550.309	190.550.309	884.190.209	843.009.000	842.009.000
147.550.409	190.550.409	884.190.209	843.009.000	842.009.000

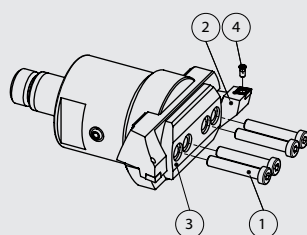

Zweischneiderköpfe

Twin cutter boring heads

• mit Innenkühlung

• with inner coolant supply



Bestell-Nr. / Order number	D	d1	ø A min.	ø A max.	L	SW / AF	Wendeplattenhalter / Insert holder
140.200.000	20	11	23.5	30.5	40	17	162.200.006 182.200.006 166.200.006 167.200.006
140.250.000	25	14	29.5	40.1	50	22	162.250.006 182.250.006 166.250.006 167.250.006
140.320.000	32	18	39.5	50.5	65	27	162.320.009 182.320.009 166.320.009 167.320.009
140.420.000	42	24	49.5	66.5	90	36	162.420.009 182.420.009 166.420.009 167.420.009
140.550.000	55	30	65.5	87.5	115	46	162.550.012/112 182.550.012/112 166.550.012 167.550.012
140.720.000	72	40	86.5	115.5	150	60	162.720.016/112 182.720.016/112 166.720.012 167.720.012
140.940.000	94	50	114.5	153	195	75	162.940.016/112 182.940.016 166.940.012 167.940.012

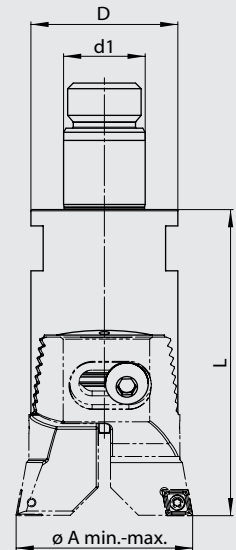

• Wendeplattenhalter müssen separat bestellt werden

• insert holders must be ordered separately

Ersatzteile / Zubehör

Spare parts / Accessories

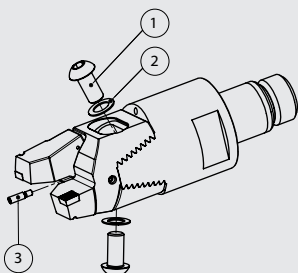

Für Zweischneiderkopf For twin cutter boring head	Bestell-Nr. / Order number	Bestell-Nr. / Order number	Bestell-Nr. / Order number
	Befestigungsschraube / Fastening screw ①	Federring / Spring washer ②	Anschlag / Stopper ③
140.200.000	840.142.200	841.142.200	841.342.200
140.250.000	840.142.250	841.142.250	841.342.200
140.320.000	840.142.320	841.142.320	841.342.200
140.420.000	840.142.420	841.142.420	841.342.420
140.550.000	840.142.550	841.142.550	841.342.420
140.720.100	840.142.720	841.142.720	841.342.420
140.940.100	840.142.940	841.142.940	841.342.420



### Wendepplattenhalter 90°

### Insert holders 90°

162

- für die Verwendung in Zweisechneiderköpfen der Serie 140

- for use in twin cutter boring heads from serie 140

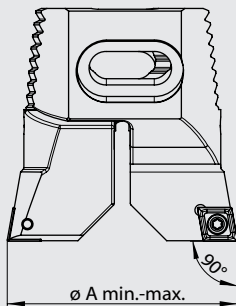

Bestell-Nr. / Order number	ø A min.	ø A max.	Wendepplatte / Insert	Zweisechneiderkopf / twin cutter boring head
162.200.006	23.5	30.5	CC ..06 02 ..	140.200.000
162.250.006	29.5	40.1	CC ..06 02 ..	140.250.000
162.320.009	39.5	50.5	CC ..09 T3 ..	140.320.000
162.420.009	49.5	66.5	CC ..09 T3 ..	140.420.000
162.550.112	65.5	87.5	CC ..12 04 ..	140.550.000
162.550.012	65.5	87.5	CN ..12 04 ..	140.550.000
162.720.112	86.5	115.5	CC ..12 04 ..	140.720.000
162.720.016	86.5	115.5	CN ..16 06 ..	140.720.000
162.940.112	114.5	153.0	CC ..12 04 ..	140.940.000
162.940.016	114.5	153.0	CN ..16 06 ..	140.940.000



- Wendepplattenhalter werden paarweise geliefert

- insert holders will be supplied in pairs

### Wendepplattenhalter 70°

### Insert holders 70°

182

- für die Verwendung in Zweisechneiderköpfen der Serie 140

- for use in twin cutter boring heads from serie 140

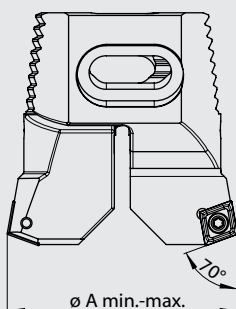

Bestell-Nr. / Order number	ø A min.	ø A max.	Wendepplatte / Insert	Zweisechneiderkopf / twin cutter boring head
182.200.006	23.5	30.5	CC ..06 02 ..	140.200.000
182.250.006	29.5	40.1	CC ..06 02 ..	140.250.000
182.320.009	39.5	50.5	CC ..09 T3 ..	140.320.000
182.420.009	49.5	66.5	CC ..09 T3 ..	140.420.000
182.550.112	65.5	87.5	CC ..12 04 ..	140.550.000
182.550.012	65.5	87.5	CN ..12 04 ..	140.550.000
182.720.112	86.5	115.5	CC ..12 04 ..	140.720.000
182.720.016	86.5	115.5	CN ..16 06 ..	140.720.000
182.940.016	114.5	153	CN ..16 06 ..	140.940.000



- Wendepplattenhalter werden paarweise geliefert

- insert holders will be supplied in pairs

### Ersatzteile / Zubehör

### Spare parts / Accessories

162/167/182

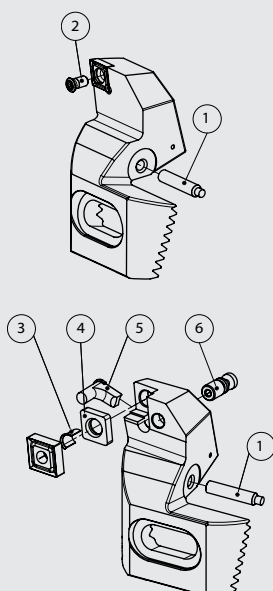

Für Wendepplattenhalter For insert holder	Bestell-Nr. / Order number	Bestell-Nr. / Order number	Bestell-Nr. / Order number	Bestell-Nr. / Order number
	Einstellschraube / Adjustment screw ①	Torx-Schraube / Torx screw ②	Torx-Schlüssel / Torx driver	
162/167/182.200.006	848.200.407	843.006.000	842.006.000	
162/167/182.250.006	848.250.409	843.006.000	842.006.000	
162/167/182.320.009	848.320.413	843.009.000	842.009.000	
162/167/182.420.009	848.420.614	843.009.000	842.009.000	
162/167/182.550.xxx	848.550.620	843.012.000	842.012.000	
162/167/182.720.xxx	848.720.000	843.012.000	842.012.000	
162/167/182.940.xxx	848.940.640	843.012.000	842.012.000	
Für Wendepplattenhalter For insert holder	Bestell-Nr. / Order number	Bestell-Nr. / Order number	Bestell-Nr. / Order number	Bestell-Nr. / Order number
	Rohrstift / Hollow pin ③	Zwischenlage / Tip pad ④	Kniehebel / Lever ⑤	Schraube zu Kniehebel / Lever screw ⑥
162/182.550.012	844.012.000	845.012.000	846.012.000	847.012.000
162/182.720.016	844.016.000	845.016.000	846.016.000	847.016.000
162/182.940.016	844.016.000	845.016.000	846.016.000	847.016.000

166

Synchro-Wendeplattenhalter 90° Synchronised insert holders 90°

- für die Verwendung in Zweischneiderköpfen der Serie 140
- mit der Synchrospindel können beide Wendeplattenhalter gleichzeitig symmetrisch eingestellt werden
- for use in twin cutter boring heads from serie 140
- with synchro spindle both insert holders can be adjusted synchronously and symmetrically



Bestell-Nr. / Order number	ø A min.	ø A max.	Wendeplatte / Insert	Zweischneiderkopf / twin cutter boring head
166.200.006	23.5	30.5	CC ..06 02 ..	140.200.000
166.250.006	29.5	40.1	CC ..06 02 ..	140.250.000
166.320.009	39.5	50.5	CC ..09 T3 ..	140.320.000
166.420.009	49.5	66.5	CC ..09 T3 ..	140.420.000
166.550.012	65.5	87.5	CC ..12 04 ..	140.550.000
166.720.012	86.5	115.5	CC ..12 04 ..	140.720.000
166.940.012	114.5	153	CC ..12 04 ..	140.940.000

- Wendeplattenhalter werden paarweise geliefert
- insert holders will be supplied in pairs

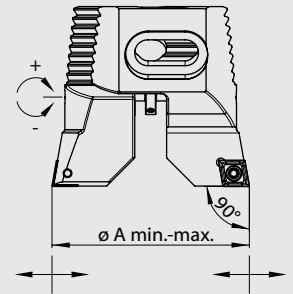

167

Wendeplattenhalter 90° axial 0.4mm zurückgesetzt Insert holders 90° axial 0.4mm staggered

- für die Verwendung in Zweischneiderköpfen der Serie 140
- zur Schnittaufteilung bei grosser Spantiefe
- for use in twin cutter boring heads from serie 140
- for divided cut



Bestell-Nr. / Order number	ø A min.	ø A max.	Wendeplatte / Insert	Zweischneiderkopf / twin cutter boring head
167.200.006	23.5	30.5	CC ..06 02 ..	140.200.000
167.250.006	29.5	40.1	CC ..06 02 ..	140.250.000
167.320.009	39.5	50.5	CC ..09 T3 ..	140.320.000
167.420.009	49.5	66.5	CC ..09 T3 ..	140.420.000
167.550.012	65.5	87.5	CC ..12 04 ..	140.550.000
167.720.012	86.5	115.5	CC ..12 04 ..	140.720.000
167.940.012	114.5	153	CC ..12 04 ..	140.940.000

- Wendeplattenhalter werden paarweise geliefert
- Ersatzteile siehe vorhergehende Seite
- insert holders will be supplied in pairs
- spare parts see previous page

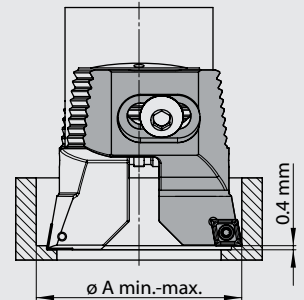

Ersatzteile / Zubehör

Spare parts / Accessories

166

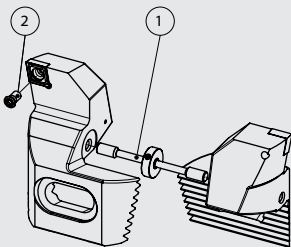

Für Wendeplattenhalter For insert holder	Bestell-Nr. / Order number	Bestell-Nr. / Order number	Bestell-Nr. / Order number
	Einstellschraube / Adjustment screw (1)	Torx-Schraube / Torx screw (2)	Torx-Schlüssel / Torx driver
166.200.006	848.200.005	843.006.000	842.006.000
166.250.006	848.250.005	843.006.000	842.006.000
166.320.009	848.320.005	843.009.000	842.009.000
166.420.009	848.420.005	843.009.000	842.009.000
166.550.012	848.550.005	843.012.000	842.012.000
166.720.012	848.720.005	843.012.000	842.012.000
166.940.012	848.940.005	843.012.000	842.012.000

**Aufnahmen mit Konsole**

**Master shanks with bridge adapter**

210

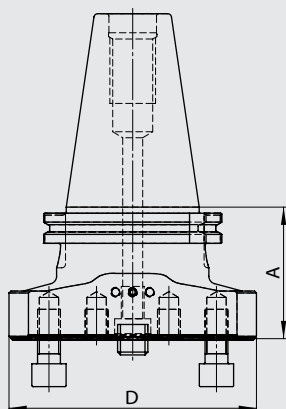

• DIN 69871 A/D

• DIN 69871 A/D

Bestell-Nr. / Order number	ISO	D	A
210.415.000	40	130	69.1
210.515.000	50	130	69.1

• MAS BT 403

• MAS BT 403

Bestell-Nr. / Order number	BT	D	A
210.412.000	40	130	77
210.512.000	50	130	88

• DIN 69893 HSK A

• DIN 69893 HSK A

Bestell-Nr. / Order number	HSK A	D	A
210.063.000	63	130	77
210.100.000	100	130	88

• Kühlmittelset muss separat bestellt werden 920.028.015

• cooling set must be ordered separately 920.028.015

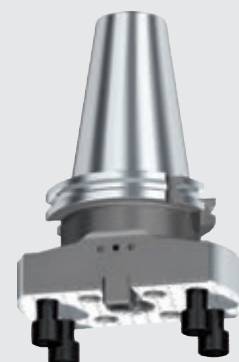
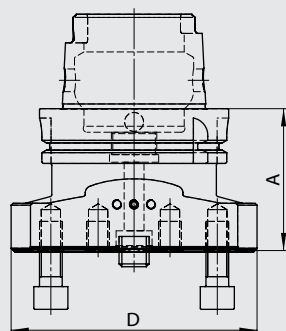

**Zwischenkonsolen**

**Bridge adapters**

210

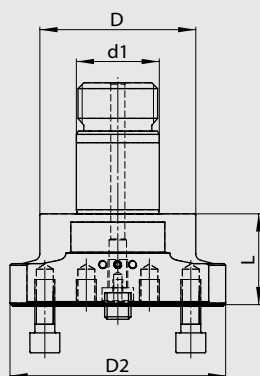

Bestell-Nr. / Order number	D	d1	D2	L	SW / AF
210.940.000	94	50	130	55	75

• Kühlmittelset muss separat bestellt werden 920.028.015

• cooling set must be ordered separately 920.028.015

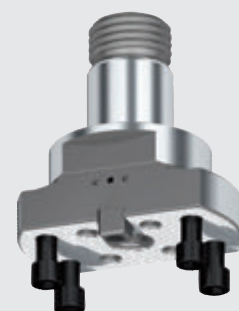

**Ersatzteile / Zubehör**

**Spare parts / Accessories**

210

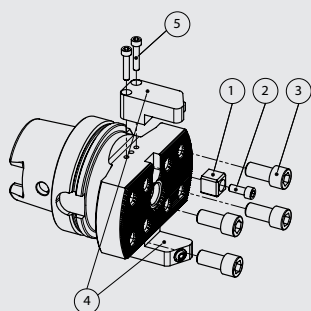

Für Konsole For bridge adapter	Bestell-Nr. / Order number	Bestell-Nr. / Order number	Bestell-Nr. / Order number
	Mitnehmerstein / Drive lug ①	Schraube / Screw ②	Befestigungsschraube / Fastening screw ③
210	810.212.362	811.210.212	812.210.212
Für Konsole For bridge adapter	Bestell-Nr. / Order number	Bestell-Nr. / Order number	
	Kühlmittelset / Cooling set ④	Befestigungsschraube / Fastening screw ⑤	
210	920.028.015	920.029.025	

**Verlängerungskonsolen**  
ø150-655

**Extension bridges**  
ø150-655

• für die Verwendung auf Konsolen der Serie 210

• for use on bridge adapters from serie 210



Bestell-Nr. / Order number	D	L	Ausdrehdurchmesser / Boring diameter
221.130.000	130	30	150 – 205
221.180.000	180	30	200 – 255
221.230.000	230	35	250 – 305
221.280.000	280	35	300 – 355
221.330.000	330	40	350 – 405
221.380.000	380	40	400 – 455
221.430.000	430	40	450 – 505
221.480.000	480	40	500 – 555
221.530.000	530	50	550 – 605
221.580.000	580	50	600 – 655

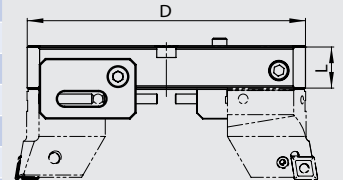

**Einstellplatte zum Überdrehen**    **Adjustment plate for pin turning**



Einstellplatte / Adjustment plate Bestell-Nr. / Order number	Für Verlängerungskonsole / For extensions bridge	D
878.221.000	221.180.000	10 - 65
878.221.000	221.230.000	60 - 115
878.221.000	221.280.000	110 - 165
878.221.000	221.330.000	160 - 215
878.221.000	221.380.000	210 - 265
878.221.000	221.430.000	260 - 315
878.221.000	221.480.000	310 - 365
878.221.000	221.530.000	360 - 415
878.221.000	221.580.000	410 - 465

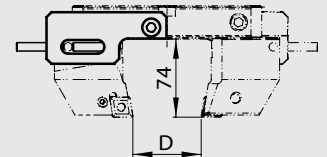

• Einstellplatten werden paarweise geliefert

• adjustment plates will be supplied in pairs

**Ersatzteile / Zubehör**

**Spare parts / Accessories**

221/223/224

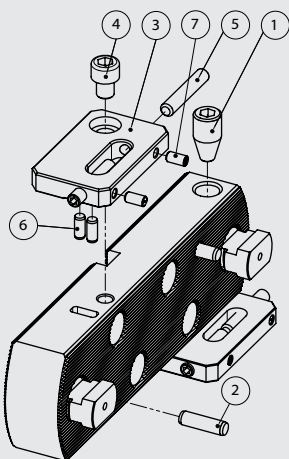

Für Verlängerungskonsole / Schieber For extension bridge / Slider	Bestell-Nr. / Order number	Bestell-Nr. / Order number	Bestell-Nr. / Order number	Bestell-Nr. / Order number
	Klemmschr. / Clamping screw ①	Stift / Pin ②		Feststellschraube / Tightening screw ⑦
221 / 224	860.220.000	864.220.000		877.221.112
Für Verlängerungskonsole / Schieber For extension bridge / Slider	Bestell-Nr. / Order number	Bestell-Nr. / Order number	Bestell-Nr. / Order number	Bestell-Nr. / Order number
	Einstellplatte / Adjustment plate ③	Schraube / Screw ④	Einstellschraube / Adjustment screw ⑤	Stift / Pin ⑥
221.130/230.000	877.221.000	877.221.012	877.221.045	877.221.014
221.180/280-580.000	877.221.000	877.221.018	877.221.045	877.221.014
224.xxx.048	877.221.000	877.221.018	877.221.045	877.221.014
Für Basis For basis	Bestell-Nr. / Order number	Bestell-Nr. / Order number	Bestell-Nr. / Order number	Bestell-Nr. / Order number
	Zentrierbuchse / Centering sleeve	Schraube m. U-Scheibe / Screw w. washer		Unterlage / Mat
223.060.xxx	878.223.012	878.223.080		878.223.005

### Wendeplattenhalter 90°

### Insert holder 90°

225

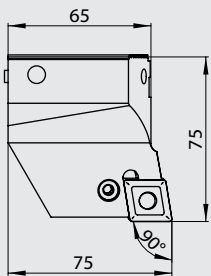

- für die Verwendung auf Verlängerungskonsolen der Serien 221 und 224

- for use on extension bridges from series 221 and 224

Bestell-Nr. / Order number	Wendeplatte / Insert
225.000.009	CC .. 09 T3 ..
225.000.012	CN .. 12 04 ..
225.000.019	CN .. 19 06 ..



- Wendeplattenhalter werden paarweise geliefert

- insert holders will be supplied in pairs

### Wendeplattenhalter 70°

### Insert holder 70°

229

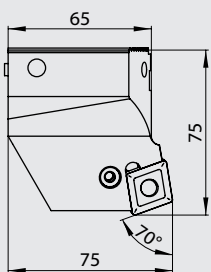

- für die Verwendung auf Verlängerungskonsolen der Serien 221 und 224

- for use on extension bridges from series 221 and 224

Bestell-Nr. / Order number	Wendeplatte / Insert
229.000.019	CN .. 19 06 ..



- Wendeplattenhalter werden paarweise geliefert

- insert holders will be supplied in pairs

### Feinbohrkopf

### Fine boring head

230

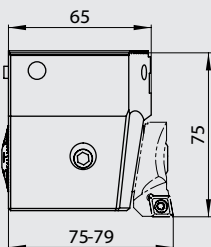

- für die Verwendung auf Verlängerungskonsolen der Serien 221 und 224
- DurchmesserEinstellung mit geringstem Umkehrspiel
- Zustellgenauigkeit von 0.01mm im Durchmesser

- for use on extension bridges from series 221 and 224
- diametrical adjustment with maximal reduced reversal backlash
- 0.01mm diametrical adjustment

Bestell-Nr. / Order number	Wendeplattenhalter
230.000.000	254.550.006 254.550.009



- Wendeplattenhalter müssen separat bestellt werden

- insert holder must be ordered separately

### Gegengewicht

### Counterweight

232

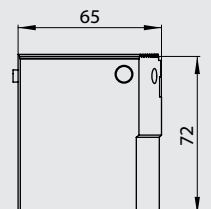

- zur Verwendung mit Feinbohrkopf der Serie 230

- for use with fine boring head from serie 230

Bestell-Nr. / Order number
232.000.000

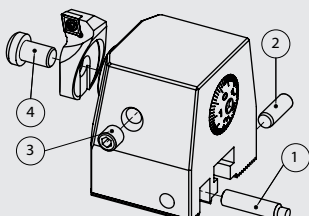

### Ersatzteile / Zubehör

### Spare parts / Accessories

230

Für Feinbohrkopf For fine boring head	Bestell-Nr. / Order number	Bestell-Nr. / Order number	Bestell-Nr. / Order number	Bestell-Nr. / Order number
	Einstellschraube / Adjustment screw	Stift / Pin	Klemmschraube / Clamping screw	Befestigungsschraube / Fastening screw
230.000.000	865.224.230	865.225.024	881.230.000	880.252.550

223/224

**Verlängerungskonsolen  
ø650-2205**

**Extension bridges  
ø650-2205**

- für die Verwendung auf Aufnahme-  
dorn ø60 / ø129 DIN 6357
- Basis aus Aluminium
- fragen Sie uns an für optimierte Kom-  
plettlösungen

- for use on holding arbor ø60 / ø129
- basis made of aluminium
- please get in touch with us for  
customized solutions

Basis / Basis Bestell-Nr. / Order number	Schieber / Slider Bestell-Nr. / Order number	D	L	Ausdrehdurchmesser / Boring diameter
223.060.063	224.310.048	630	128	650 – 1105
223.060.108	224.360.048	1080	128	1100 - 1655
223.060.163	224.360.048	1630	128	1650 – 2205

- Schieber müssen separat bestellt wer-  
den und werden paarweise geliefert
- Ersatzteile siehe vorhergehende Seite

- sliders must be ordered separatly  
and will be supplied in pairs
- spare parts see previous page

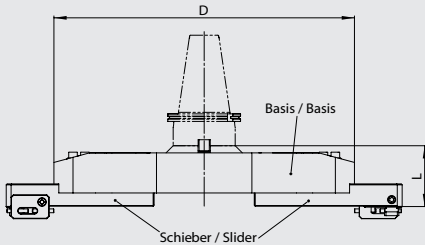

**Ersatzteile / Zubehör**

**Spare parts / Accessories**

225/229

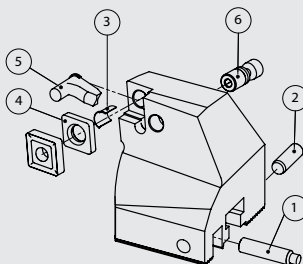

Für Wendepaltenhalter For insert holder	Bestell-Nr. / Order number	Bestell-Nr. / Order number	Bestell-Nr. / Order number	Bestell-Nr. / Order number
	Einstellschraube / Adjustment screw ①	Stift / Pin ②	Torx-Schraube / Torx screw	Torx-Schlüssel / Torx driver
225.000.009	865.224.230	865.225.024	843.009.000	842.009.000
225.000.012	865.224.230	865.225.024		
225.000.019	865.224.230	865.225.024		
229.000.019	865.224.230	865.225.024		
Für Wendepaltenhalter For insert holder	Bestell-Nr. / Order number	Bestell-Nr. / Order number	Bestell-Nr. / Order number	Bestell-Nr. / Order number
	Rohrstift / Hollow pin ③	Zwischenlage / Tip pad ④	Kniehebel / Lever ⑤	Schraube zu Kniehebel / Lever screw ⑥
225.000.012	844.012.000	845.012.000	846.012.000	847.012.000
225.000.019	844.019.000	845.019.000	846.019.000	847.019.000
229.000.019	844.019.000	845.019.000	846.019.000	847.019.000

### High-Speed Feinbohrköpfe

### High-Speed fine boring heads

280

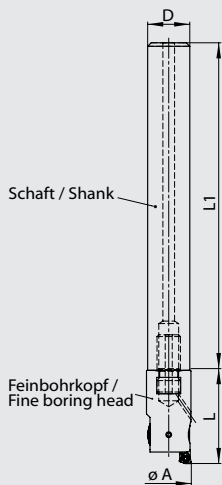

- mit Hartmetallschaft
- Durchmessereinstellung mit geringstem Umkehrspiel
- Zustellgenauigkeit von 0.01mm
- mit Innenkühlung

- with solid carbide shank
- diametrical adjustment with maximal reduced reversal backlash
- 0.01mm diametrical adjustment
- with inner coolant supply

Feinbohrkopf / Fine boring head Bestell-Nr. / Order number	HS-Schaft / HS-shank Bestell-Nr. / Order number	D	ø A min.	ø A max.	L	für Wendeplat- tenhalter / For insert holder
280.140.000	276.014.006	14	14.7	17.1	150	282.005.002
280.160.000	276.016.010	16	16.7	20.1	160	282.005.002
280.190.000	276.018.110	18	19.7	24.1	180	282.005.002
280.200.000	276.020.010	20	23.9	31.1	250	254.200.006
280.250.000	276.025.012	25	30.9	40.1	306	254.250.006
280.320.000	276.032.016	32	39.9	51.1	380	254.320.006

- Feinbohrkopf, Schaft und Wendeplattenhalter müssen separat bestellt werden
- Wendeplattenhalter der Serie 254 siehe Seite 17

- fine boring head, shank and insert holder must be ordered separately
- insert holder from serie 254 see page 17



### Wendeplattenhalter

### Insert holders

282

Bestell-Nr. / Order number	Wendeplatte / Insert	Feinbohrkopf / Fine boring head
		280.140.000
282.005.002	WC . . 02 01 . .	280.160.000
		280.190.000



### Ersatzteile / Zubehör

### Spare parts / Accessories

280/282

Für Feinbohrkopf For fine boring head	Bestell-Nr. / Order number	Bestell-Nr. / Order number
	Klemmschraube / Clamping screw ①	Befestigungsschraube / Fastening screw ②
280.140.000	881.280.140	882.280.140
280.160.000	881.280.160	882.280.140
280.190.000	881.280.190	882.280.140
280.200.000	881.252.200	880.252.200
280.250.000	881.252.250	880.252.250
280.320.000	881.252.320	880.252.320
Für Einsatz For tip holder	Bestell-Nr. / Order number	Bestell-Nr. / Order number
	Torx-Schraube / Torx screw ③	Torx-Schlüssel / Torx driver
282.005.002	843.005.000	842.005.000

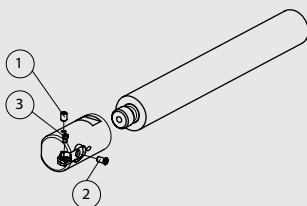

Feinbohrköpfe

Fine boring heads

- DurchmesserEinstellung mit geringstem Umkehrspiel
- Zustellgenauigkeit von 0.01mm resp. über Nonius 0.002mm im Durchmesser
- mit Innenkühlung

- diametrical adjustment nearly without reversal backlash
- 0.01mm diametrical adjustment resp. 0.002mm by nonius
- with inner coolant supply



Bestell-Nr. / Order number	D	d1	ø A min.	ø A max.	L	SW	Wendeplattenhal- ter / Insert holder
250.200.000	20	11	23.9 29.9	31.1 37.1	40	17	254.200.006 254.201.006
250.250.000	25	14	30.9 37.9	40.1 47.1	50	22	254.250.006 254.251.006
250.320.000	32	18	39.9 47.9	51.1 59.1	65	27	254.320.006 254.321.006
250.420.000	42	24	50.9 64.9	67.1 81.1	90	36	254.420.006 254.421.006
250.550.000	55	30	66.9 84.9	87.1 105.1	115	46	254.550.009 254.550.006 254.551.006/9
250.720.000	72	40	86.9 104.9	116.1 134.1	75	60	254.550.009 254.550.006 254.551.006/9
250.940.000	94	50	115.9 133.9	153.1 171.1	99	75	254.550.009 254.550.006 254.551.006/9

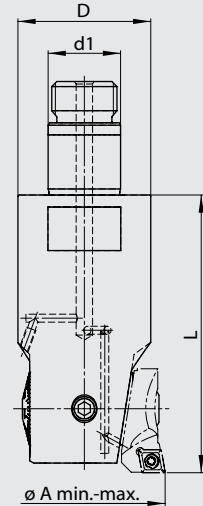

- die fettgedruckten Nummern sind für eine optimale Stabilität zu bevorzugen
- Wendeplattenhalter müssen separat bestellt werden

- the highlighted articles meet high end stability needs
- insert holders must be ordered separately

Ersatzteile / Zubehör

Spare parts / Accessories

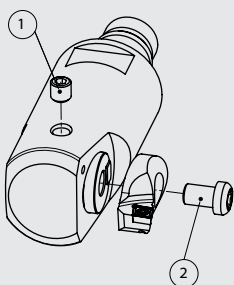

Für Feinbohrkopf For fine boring head	Bestell-Nr. / Order number	Bestell-Nr. / Order number
	Klemmschraube / Clamping screw (1)	Befestigungsschraube / Fastening screw (2)
250.200.000	881.252.200	880.252.200
250.250.000	881.252.250	880.252.250
250.320.000	881.252.320	880.252.320
250.420.000	881.252.420	880.252.420
250.550.000	881.252.550	880.252.550
250.720.000	881.252.720	880.252.550
250.940.000	881.252.940	880.252.550



Wendepplattenhalter 90°

Insert holders 90°

254

• für die Verwendung in Feinbohrköpfen der Serie 230 und 250

• for use in fine boring heads from serie 230 and 250

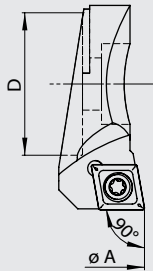

Bestell-Nr. / Order number	ø A min.	ø A max.	D	Wendepplatte / Insert	Feinbohrkopf / fine boring head
<b>254.200.006</b>	23.9	31.1	11	CC .. 06 02 ..	<b>250.200.000</b>
254.201.006	29.9	37.1	11	CC .. 06 02 ..	250.200.000
<b>254.250.006</b>	30.9	40.1	13	CC .. 06 02 ..	<b>250.250.000</b>
254.251.006	37.9	47.1	13	CC .. 06 02 ..	250.250.000
<b>254.320.006</b>	39.9	51.1	17	CC .. 06 02 ..	<b>250.320.000</b>
254.321.006	47.9	59.1	17	CC .. 06 02 ..	250.320.000
<b>254.420.006</b>	50.9	67.1	22	CC .. 06 02 ..	<b>250.420.000</b>
254.421.006	64.9	81.1	22	CC .. 06 02 ..	250.420.000
254.550.006	66.9	87.1	30	CC .. 06 02 ..	250.550.000
<b>254.550.009</b>	66.9	87.1	30	CC .. 09 T3 ..	<b>250.550.000</b>
254.551.006	84.9	105.1	30	CC .. 06 02 ..	250.550.000
254.551.009	84.9	105.1	30	CC .. 09 T3 ..	250.550.000
254.550.006	86.9	116.1	30	CC .. 06 02 ..	250.720.000
<b>254.550.009</b>	86.9	116.1	30	CC .. 09 T3 ..	<b>250.720.000</b>
254.551.006	104.9	134.1	30	CC .. 06 02 ..	250.720.000
254.551.009	104.9	134.1	30	CC .. 09 T3 ..	250.720.000
254.550.006	115.9	153.1	30	CC .. 06 02 ..	250.940.000
<b>254.550.009</b>	115.9	153.1	30	CC .. 09 T3 ..	<b>250.940.000</b>
254.551.006	133.9	171.1	30	CC .. 06 02 ..	250.940.000
254.551.009	133.9	171.1	30	CC .. 09 T3 ..	250.940.000



• die fettgedruckten Nummern sind, für eine optimale Stabilität, zu bevorzugen

• the highlighted articles meet high end stability needs

Wendepplattenhalter 95°

Insert holders 95°

254

• für die Verwendung in Feinbohrköpfen der Serie 230 und 250

• for use in fine boring heads from serie 230 and 250

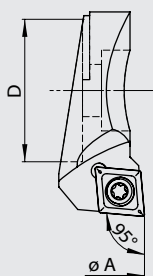

Bestell-Nr. / Order number	ø A min.	ø A max.	D	Wendepplatte / Insert	Feinbohrkopf / fine boring head
254.205.006	23.9	31.1	11	CC .. 06 02 ..	250.200.000
254.255.006	30.9	40.1	13	CC .. 06 02 ..	250.250.000
254.325.006	39.9	51.1	17	CC .. 06 02 ..	250.320.000
254.425.006	50.9	67.1	22	CC .. 06 02 ..	250.420.000
254.555.009	66.9	87.1	30	CC .. 09 T3 ..	250.550.000
254.555.009	86.9	116.1	30	CC .. 09 T3 ..	250.720.000
254.555.009	115.9	153.1	30	CC .. 09 T3 ..	250.940.000



Ersatzteile / Zubehör

Spare parts / Accessories

254

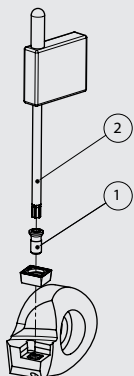

Für Wendepplattenhalter For insert holder	Bestell-Nr. / Order number	Bestell-Nr. / Order number
	Torx-Schraube / Torx screw ①	Torx-Schlüssel / Torx driver ②
254.xxx.006	843.006.000	842.006.000
254.xxx.009	843.009.000	842.009.000

**Umkehradapter  
für Rückwärtsbearbeitung**

**Reversal adapter  
for reverse machining**

- für die Verwendung in Feinbohrköpfen der Serie 250
- damit können die Wendepaltenhalter der Serie 254 rückwärts montiert werden

- for use in fine boring heads from serie 250
- the insert holders from serie 254 will be fitted backwards on the adapter

Bestell-Nr. / Order number	ø A min.	ø A max.	D	L	X	Feinbohrkopf / fine boring head
255.200.001	37	44	20	13.0	6.5	250.200.000
255.200.002	40	51	20	13.0	8.0	250.200.000
255.250.001	44	53	25	17.6	6.5	250.250.000
255.250.002	51	60	25	17.6	10.0	250.250.000
255.320.001	53	64	32	31.3	6.5	250.320.000
255.320.002	60	71	32	31.3	10.0	250.320.000
255.420.001	64	80	42	49.2	6.5	250.420.000
255.420.002	75	91	42	49.2	12.0	250.420.000
255.550.000	87	107	55	62.0	10.0	250.550.000
255.550.000	107	136	72	22.0	10.0	250.720.000
255.550.000	136	173	94	46.0	10.0	250.940.000

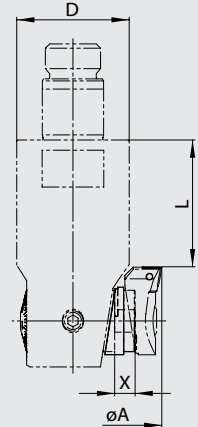

- Befestigungsschrauben werden mitgeliefert
- Achtung: Linkslauf

- fastening screws will be delivered with adapters
- Caution: counterclockwise rotation

**Einfahren**  
Enter into the bore

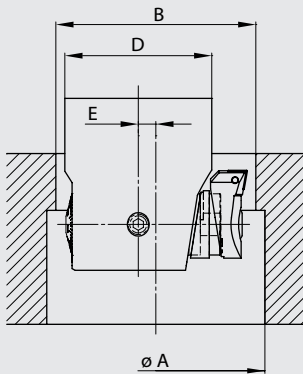

- Minstdurchmesser der Eintrittsbohrung

$$B = \frac{D + A}{2} + 1^*$$

- Mindestversatz zum Einfahren

$$E = \frac{A - B}{2} + 0.5^*$$

\*Sicherheitsabstand

- minimum entry bore diameter

$$B = \frac{D + A}{2} + 1^*$$

- minimum off centre to enter into the bore

$$E = \frac{A - B}{2} + 0.5^*$$

\*safety distance

**Rückwärtsbearbeitung**  
Back boring

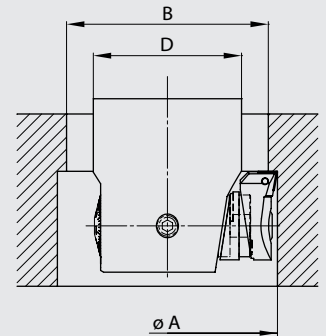

**Ersatzteile / Zubehör**

**Spare parts / Accessories**

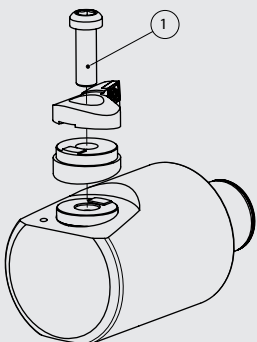

Für Umkehradapter For reversal adapter	Bestell-Nr. / Order number	Befestigungsschraube / Fastening screw ①
255.200.001	880.252.201	
255.200.002	880.252.202	
255.250.001	880.252.251	
255.250.002	880.252.252	
255.320.001	880.252.321	
255.320.002	880.252.322	
255.420.001	880.252.421	
255.420.002	880.252.422	
255.550.000	880.252.551	

Feinbohrkopf ø86-402

Fine boring head ø86-402

257

- Durchmessereinstellung mit geringstem Umkehrspiel
- Zustellgenauigkeit von 0.01mm im Durchmesser
- mit Innenkühlung
- diametrical adjustment with maximal reduced reversal backlash
- 0.01mm diametrical adjustment
- with inner coolant supply

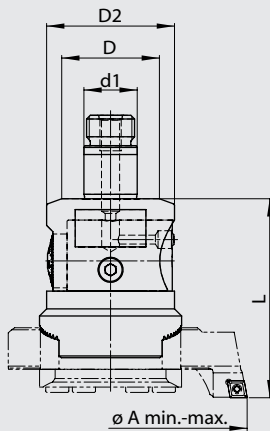

Bestell-Nr. / Order number	D	d1	D2	ø A min.	ø A max.	L	SW / AF
257.550.000	55	30	72	86	402	112	60

- Wendeplattenhalter der Serie 259 müssen separat bestellt werden
- insert holders from serie 259 must be ordered separately



Wendeplattenhalter inkl.  
Druckplatte und Abstützung

Insert holders incl.  
clamp plate and support block

259

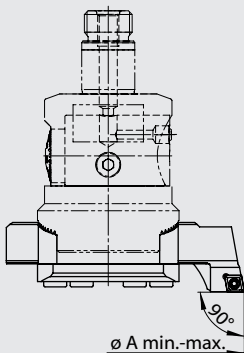

Bestell-Nr. / Order number	ø A min.	ø A max.	Wendeplatte / Insert
259.550.109	86	138	CC.. 09 T3 ..
259.550.112	86	138	CC.. 12 04 ..
259.550.209	136	220	CC.. 09 T3 ..
259.550.212	136	220	CC.. 12 04 ..
259.550.309	188	302	CC.. 09 T3 ..
259.550.409	242	402	CC.. 09 T3 ..



Ersatzteile / Zubehör

Spare parts / Accessories

257/259

Für Feinbohrkopf For fine boring head	Bestell-Nr. / Order number	Bestell-Nr. / Order number
	Klemmschraube / Clamping screw ①	Befestigungsschraube / Fastening screw ②
257.550.000	850.256.550	850.144.550

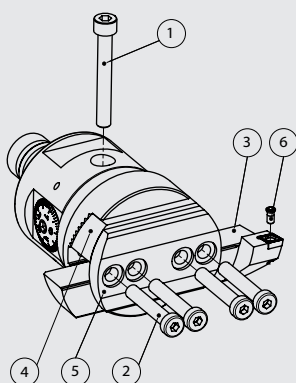

Für Wendeplattenhalter set	Bestell-Nr. / Order number	Bestell-Nr. / Order number	Bestell-Nr. / Order number	Bestell-Nr. / Order number	Bestell-Nr. / Order number
	Wendeplattenhalter / Insert holder ③	Abstützung / Support block ④	Druckplatte / Clamp plate ⑤	Torx-Schraube / Torx screw ⑥	Torx-Schlüssel / Torx driver
259.550.109	190.550.109	885.190.109	884.190.109	843.009.000	842.009.000
259.550.112	190.550.112	885.190.109	884.190.109	843.012.000	842.012.000
259.550.209	190.550.209	885.190.209	884.190.209	843.009.000	842.009.000
259.550.212	190.550.212	885.190.209	884.190.209	843.012.000	842.012.000
259.550.309	190.550.309	885.190.209	884.190.209	843.009.000	842.009.000
259.550.409	190.550.409	885.190.209	884.190.209	843.009.000	842.009.000



- DurchmesserEinstellung mit geringstem Umkehrspiel
- Zustellgenauigkeit von 0.01mm resp. über Nonius 0.002mm im Durchmesser
- mit Innenkühlung
- Ausdrehstähle durchschiebbar

- diametrical adjustment with maximal reduced reversal backlash
- 0.01mm diametrical adjustment resp. 0.002mm by nonius
- with inner coolant supply
- boring bars go through head

Bestell-Nr. / Order number	D	d1	D2	ø A min.	ø A max.	L	L1	SW / AF
<b>CAD 55 modular</b>								
260.420.045	42	24	10	3	19	45	40	36
260.550.053	55	30	16	3	88.1	53	50	46
<b>DIN 69893 HSK 63 A</b>								
269.063.095	55	-	16	3	88.1	95	70	-
<b>DIN 69871 AD 40</b>								
269.415.090	55	-	16	3	88.1	90	80	-
<b>MAS BT 40</b>								
269.412.090	55	-	16	3	88.1	90	80	-

- Länge L1 bezeichnet die maximale Durchlasstiefe für den Ausdrehstahl
- Ausdrehstähle müssen separat bestellt werden
- die Ausdrehdurchmesser ø A min. - A max. werden mit Ausdrehstählen der Serien 272 bis 278 erreicht

- length L1 stands for the maximal put in depth for the boring bar
- boring bars must be ordered separately
- boring diameter ø A min. - A max. are only available with boring bars from series 272 to 278

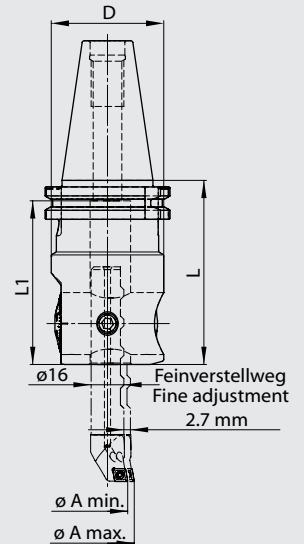
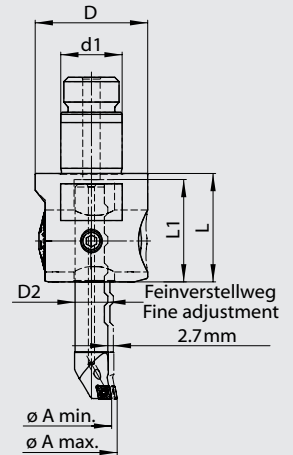

Universal-Auswuchtringe

Universal balancing rings

- zum Auswuchten verstellbarer Werkzeuge, z.B. Ausdrehköpfe der Serien 260 - 263
- für die Ausdrehköpfe der Serie 260 und 263 (mit den Ausdrehstählen der Serie 272,274,276,278) sind Einstelltabellen verfügbar, womit die Unwucht über 90% reduziert wird

- to balance adjustable tools, e.g. fine boring heads from series 260-263
- balancing charts for fine boring heads from serie 260 and 263 (with boring bars from serie 272,274,276,278) are available in order to reduce unbalance by 90%

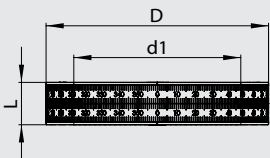

Bestell-Nr. / Order number	D	d1	L
264.550.100	75	55	16



Ersatzteile / Zubehör

Spare parts / Accessories

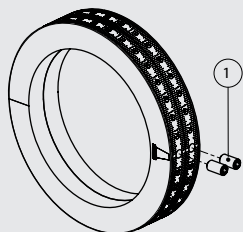

Für Auswuchtring For balancing ring	Bestell-Nr. / Order number
	Klemmschraube / Clamp screw ①
264.xxx.100	857.550.000

MULTI-  
HEAD

Ausdrehkopf ø3-320

Fine boring head ø3-320

261

- für Ausdrehstähle mit Schaftdurchmesser 16mm und Feinbohrbrücken
- Durchmessereinstellung mit geringstem Umkehrspiel
- Zustellgenauigkeit von 0.01mm resp. über Nonius 0.002mm im Durchmesser
- mit Innenkühlung
- Ausdrehstähle durchschiebbar

- for boring bars with a shank diameter of 16mm and fine boring bridges
- diametrical adjustment with maximal reduced reversal backlash
- 0.01mm diametrical adjustment resp. 0.002mm by nonius
- with inner coolant supply
- boring bars go through head

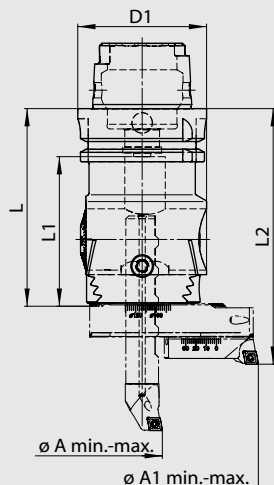

Bestell-Nr. / Order number	D	ø A min.- max.	ø A1 min.- max.	L	L1	L2
<b>DIN 69893 HSK 63 A</b>						
261.063.095	63	3 - 88.1	86 - 320	96	72.5	125
<b>DIN 69871 AD 40</b>						
261.415.090	63	3 - 88.1	86 - 320	91	81	120
<b>MAS BT 40</b>						
261.412.090	63	3 - 88.1	86 - 320	91	81	120

- Länge L1 bezeichnet die maximale Durchlasstiefe für den Ausdrehstahl
- Ausdrehstähle, Feinbohrbrücken und Wendepaltenhalter müssen separat bestellt werden.
- die Ausdrehdurchmesser ø A min.-max. werden mit Ausdrehstählen der Serien 270 bis 278 erreicht
- die Ausdrehdurchmesser ø A1 min.-max. werden mit Feinbohrbrücken der Serie 886 erreicht

- length L1 stands for the maximal put in depth for the boring bar
- boring bars, fine boring bridges and insert holders must be ordered separately
- boring diameters ø A min.-max. are only available with boring bars from series 270 to 278
- boring diameters ø A min.-max. are only available with fine boring bridges from serie 886



Ersatzteile / Zubehör

Spare parts / Accessories

260/261/269/886

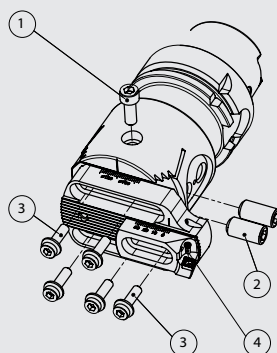

Für Ausdrehkopf For boring head	Bestell-Nr. / Order number	Bestell-Nr. / Order number	Bestell-Nr. / Order number
	Klemmschraube / Clamping screw ①	Befestigungsschraube / Fastening screw ②	Befestigungsschraube / Fastening screw ③
261.550.065	881.261.016	881.261.020	883.261.016
Für Wp-Halter For insert holder	Bestell-Nr. / Order number	Bestell-Nr. / Order number	
	Torx-Schraube / Torx screw ④	Torx-Schlüssel / Torx driver	
253.048.006	843.006.000	842.006.000	
253.048.009	843.009.000	842.009.000	

Für Ausdrehkopf For boring head	Bestell-Nr. / Order number	Bestell-Nr. / Order number
	Klemmschraube / Clamping screw ①	Befestigungsschraube / Fastening screw ②
260.420.045	881.262.420	882.262.420
260.550.053	881.262.551	882.262.551
269.xxx.xxx	881.262.551	882.262.551



**Aluminium-Brücken**

- mit Innenkühlung

**Aluminium bridges**

- with inner coolant supply

Bestell-Nr. / Order number	D	ø A min.	ø A max.
886.086.164	80	86	164
886.162.320	158	162	320

**Wendeplattenhalter**

- mit Innenkühlung

**Insert holders**

- with inner coolant supply



Bestell-Nr. / Order number	Wendeplatte / Insert	ø A min.	ø A max.
253.048.006	CC .. 06 02 ..	86	320
253.048.009	CC .. 09 T3 ..	86	320

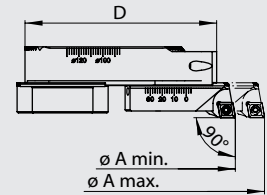

**Gegengewicht**

- für hohe Drehzahlen

**Counter weight**

- for high revolution speed

Bestell-Nr. / Order number
886.038.045

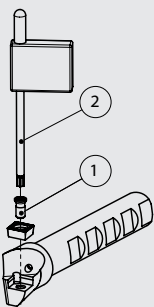

**Ersatzteile / Zubehör**

**Spare parts / Accessories**

272

Für Ausdrehstahl For boring bar	Bestell-Nr. / Order number	Bestell-Nr. / Order number
	Torx-Schraube / Torx screw ①	Torx-Schlüssel / Torx driver ②
272.010-012.006	843.007.000	842.006.000
272.xxx.006	843.006.000	842.006.000
272.xxx.009	843.009.000	842.009.000

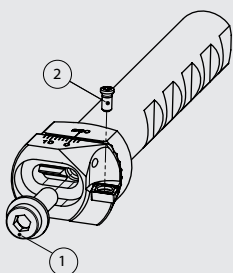

**Ersatzteile / Zubehör**

**Spare parts / Accessories**

271/253

Für Schaft For shank	Bestell-Nr. / Order number	Für Wp-Halter For insert holder	Bestell-Nr. / Order number	Bestell-Nr. / Order number
	Befestigungsschraube / Fastening screw ①		Torx-Schraube / Torx screw ②	Torx-Schlüssel / Torx driver
271.030.048	883.261.016	253.xxx.006	843.006.000	842.006.000
271.048.088	883.261.016	253.xxx.009	843.009.000	842.009.000

**Ausdrehstähle ø9.75-88.1**

**Boring bars ø9.75-88.1**

272

- mit Innenkühlung
- werden die Ausdrehstähle zentrisch gespannt (Weldonfutter), kann mit ø A min. ausgedreht werden

- with inner coolant supply
- if the boring bars are clamped centrally (weldon adapter), the minimum diameter (ø A min.) is provided

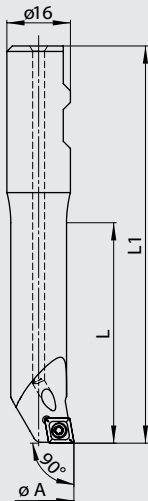

Bestell-Nr. / Order number	ø A min.	ø A max.	L	L1	Wendeplatte / Insert
272.010.006	9.75	15.1	30	75	CC .. 06 02 ..
272.012.006	11.75	17.1	37	80	CC .. 06 02 ..
272.014.006	13.75	19.1	43	85	CC .. 06 02 ..
272.015.006	14.75	20.1	51	90	CC .. 06 02 ..
272.016.006	15.75	21.1	57	95	CC .. 06 02 ..
272.018.006	17.75	23.1	67	100	CC .. 06 02 ..
272.020.006	19.75	25.1	72	105	CC .. 06 02 ..
272.020.009	19.75	25.1	72	105	CC .. 09 T3 ..
272.022.009	21.75	27.1	77	110	CC .. 09 T3 ..
272.025.006	24.75	30.1	82	115	CC .. 06 02 ..
272.025.009	24.75	30.1	82	115	CC .. 09 T3 ..
272.028.009	27.75	33.1	82	115	CC .. 09 T3 ..

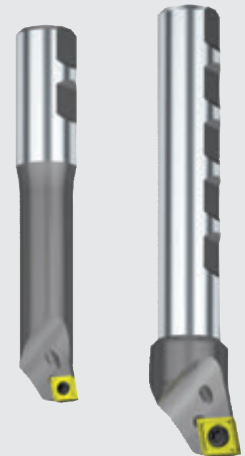

- Länge L bezeichnet die maximale Ausdrehlänge
- die Ausdrehdurchmesser ø A min. - A max. werden mit Ausdrehköpfen der Serien 260 bis 269 erreicht

- length L stands for the maximal boring depth
- boring diameters ø A min. - A max. are only available with fine boring heads from series 260 to 269

**Verstellbare Ausdrehstähle ø29.75-88.1**

**Adjustable boring bars ø29.75-88.1**

253/271

- sehr gute Dämpfungseigenschaften

- high end absorbability

**Schäfte**

- mit Innenkühlung

**Shanks**

- with inner coolant supply

Bestell-Nr. / Order number	ø A min.	ø A max.	L	L1	für Wendeplattenhalter / for insert holder
271.030.048	29.75	48.1	85	115	253.030.006
271.048.088	47.75	88.1	85	115	253.048.xxx

**Wendeplattenhalter**

- mit Innenkühlung

**Insert holders**

- with inner coolant supply

Bestell-Nr. / Order number	ø A min.	ø A max.	Wendeplatte / Insert	für Schaft / for shank
253.030.006	29.75	48.1	CC .. 06 02 ..	271.030.048
253.048.006	47.75	88.1	CC .. 06 02 ..	271.048.088
253.048.009	47.75	88.1	CC .. 09 T3 ..	271.048.088

- Länge L bezeichnet die maximale Ausdrehlänge
- ab ø67 kann die Ausdrehlänge mit Verlängerungen der Serie 130 erhöht werden
- die Ausdrehdurchmesser ø A min. - A max. werden mit Ausdrehköpfen der Serien 260 bis 269 erreicht
- Schäfte und Wendeplattenhalter müssen separat bestellt werden

- length L stands for the maximal boring depth
- using boring bars for ø67 or bigger the maximal boring depth can be increased by extensions from serie 130
- boring diameters ø A min. - A max. are only available with fine boring heads from series 260 to 269
- shanks and insert holder must be ordered separately

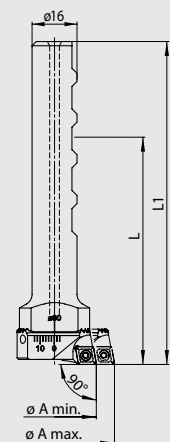

265

Reduktionshülsen

Reduction sleeves



Bestell-Nr. / Order number	D	d1	L
265.010.004	10	4	29,5
265.010.005	10	5	29,5
265.010.006	10	6	29,5
265.010.008	10	8	29,5
265.016.004	16	4	37
265.016.005	16	5	37
265.016.006	16	6	37
265.016.008	16	8	37
265.016.009	16	9	37
265.016.010	16	10	37
265.016.011	16	11	37
265.016.012	16	12	37
265.016.013	16	13	37
265.016.014	16	14	37

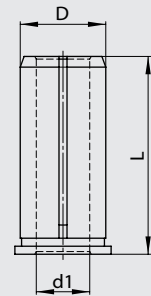

268

Ausdrehstahl-Verlängerungen

Boring bar extensions



Bestell-Nr. / Order number	D	d1	D2	L	L1
268.016.010	16	10	16	128	-
268.016.016	16	16	24	148	44

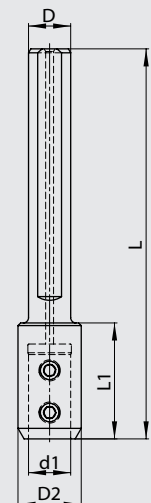

Ersatzteile / Zubehör

Spare parts / Accessories

268

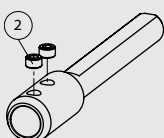

Für Ausdrehstahl-Verlängerung  
For boring bar extension

Bestell-Nr. /  
Order number

Spannschraube /  
Clamp screw ②

268.016.010

855.268.006

268.016.016

855.268.008



**Ausdrehstähle  
mit Hartmetallschneide**

**Boring bars  
with carbide tips**

275

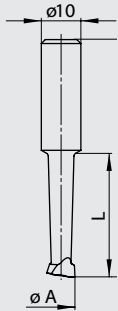

Bestell-Nr. / Order number	$\varnothing A$ min.	$\varnothing A$ max.	L	HM Sorte / Carbide quality
275.003.010	3.0	8.0	20	K10
275.003.020	3.0	8.0	20	P20
275.004.010	4.0	9.0	23	K10
275.004.020	4.0	9.0	23	P20
275.005.010	5.0	10.0	25	K10
275.005.020	5.0	10.0	25	P20
275.006.010	6.0	11.0	28	K10
275.006.020	6.0	11.0	28	P20
275.007.010	7.0	12.0	31	K10
275.007.020	7.0	12.0	31	P20
275.009.010	9.0	14.0	34	K10
275.009.020	9.0	14.0	34	P20
275.010.010	10.0	15.0	37	K10
275.010.020	10.0	15.0	37	P20
275.012.010	12.0	17.0	40	K10
275.012.020	12.0	17.0	40	P20
275.014.010	14.0	19.0	43	K10
275.014.020	14.0	19.0	43	P20



- die Ausdrehdurchmesser  $\varnothing A$  min. - A max. werden mit Ausdrehköpfen der Serien 260 bis 269 erreicht
- Hartmetall Sorte K10 für Guss, Aluminium usw.
- Hartmetall Sorte P20 für Stahl, Chromnickelstahl usw.
- boring diameters  $\varnothing A$  min. - A max. are only available with fine boring heads from series 260 to 269
- carbide quality K10 for cast iron, aluminium etc.
- carbide quality P20 for steel, chrome nickel steel etc.

**Ausdrehstähle  
mit Hartmetallschaft**

**Boring bars  
with solid carbide shank**

274

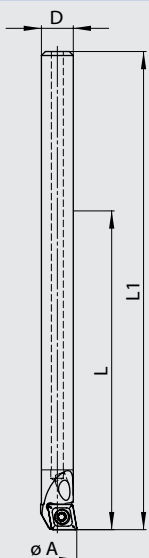

Bestell-Nr. / Order number	$\varnothing A$ min.	$\varnothing A$ max.	D	L	L1	Wendeplatte / Insert
274.006.002	5.8	11.2	5	50	85	WC..02 01 ..
274.008.002	7.8	13.2	6	60	95	WC..02 01 ..
274.010.006	9.8	15.0	8	80	120	CC..06 02 ..
274.014.006	13.8	19.0	10	100	140	CC..06 02 ..
274.018.009	17.8	23.0	12	120	170	CC..09 T3 ..
274.022.009	21.8	27.0	16	160	210	CC..09 T3 ..



- Länge L bezeichnet die maximale Ausdrehlänge
- die Ausdrehdurchmesser  $\varnothing A$  min. - A max. werden mit Ausdrehköpfen der Serien 260 bis 269 erreicht
- length L stands for the maximal boring depth
- boring diameters  $\varnothing A$  min. - A max. are only available with fine boring heads from series 260 to 269

**Ersatzteile / Zubehör**

**Spare parts / Accessories**

274

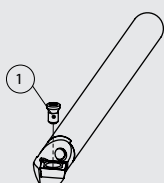

Für Ausdrehstahl For boring bar	Bestell-Nr. / Order number	Bestell-Nr. / Order number
	Torx-Schraube / Torx screw ①	Torx-Schlüssel / Torx driver
274.xxx.002	843.005.000	842.005.000
274.010.006	843.007.000	842.006.000
274.xxx.006	843.006.000	842.006.000
274.xxx.009	843.009.000	842.009.000

278/276

**High-Speed Ausdrehstähle  
ø8.75-40.1 (Hartmetallschaft)**

**High-Speed boring bars  
ø8.75-40.1 (solid carbide shank)**

- zum Ausdrehen von langen Bohrungen
- sehr gute Dämpfungseigenschaften durch Hartmetallschaft
- mit Innenkühlung

- to machine long holes
- high end absorbability by solid carbide shank
- with inner coolant supply



HS-Kopf / HS-head Bestell-Nr. / Order number	HS-Schaft / HS-shank Bestell-Nr. / Order number	ø A min.	ø A max.	D	L	L1	Wende- platte / Insert
278.087.005	276.008.005	8.75	14.1	8	56	91	CC..06 02..
278.097.005	276.009.005	9.75	15.1	9	63	98	CC..06 02..
278.107.006	276.010.006	10.75	16.1	10	70	105	CC..06 02..
278.117.006	276.011.006	11.75	17.1	11	77	112	CC..06 02..
278.127.006	276.012.006	12.75	18.1	12	84	119	CC..06 02..
278.137.006	276.013.006	13.75	19.1	13	91	126	CC..06 02..
278.147.006	276.014.006	14.75	20.1	14	98	133	CC..06 02..
278.157.006	276.014.006	15.75	21.1	14	98	133	CC..06 02..
278.167.006	276.016.010	16.75	22.1	16	112	147	CC..06 02..
278.177.006	276.016.010	17.75	23.1	16	112	147	CC..06 02..
278.197.006	276.016.010	19.75	25.1	16	112	147	CC..06 02..
278.217.006	276.016.010	21.75	27.1	16	112	147	CC..06 02..
278.247.006	276.016.010	24.75	30.1	16	112	147	CC..06 02..
278.277.006	276.016.010	27.75	33.1	16	112	147	CC..06 02..
278.317.006	276.016.010	31.75	37.1	16	112	147	CC..06 02..
278.347.006	276.016.010	34.75	40.1	16	112	147	CC..06 02..

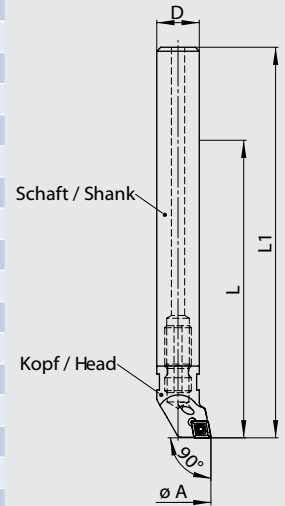

- Länge L bezeichnet die maximale Ausdrehlänge
- die maximale Ausdrehlänge kann mit den Verlängerungen der Serie 286 verlängert werden
- die Ausdrehdurchmesser ø A min. - A max. werden mit Ausdrehköpfen der Serien 260 bis 269 erreicht
- Kopf und Schaft müssen separat bestellt werden

- length L stands for the maximal boring depth
- the maximal boring depth can be increased by extensions from serie 286
- boring diameters ø A min. - A max. are only available with fine boring heads from series 260 to 269
- head and shank must be ordered separately

**Ersatzteile / Zubehör**

**Spare parts / Accessories**

276/278

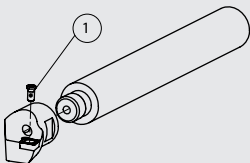

Für Kopf For head	Bestell-Nr. / Order number	Bestell-Nr. / Order number
	Torx-Schraube / Torx screw ①	Torx-Schlüssel / Torx driver
278.087.005-278.117.006	843.007.000	842.006.000
278.127.006-278.347.006	843.006.000	842.006.000

## Überdrehhalter ø5.3-48.6

## Pin turning adapter ø5.3-48.6

279/278

- für die Verwendung in Ausdrehköpfen der Serien 260 bis 269
- mit Innenkühlung

- for use in fine boring heads from series 260 to 269
- with inner coolant supply

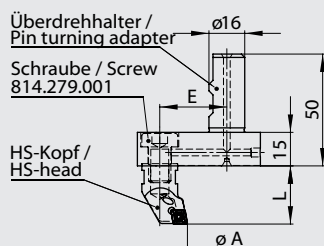

Überdrehhalter / Pin turning adapter Bestell-Nr. / Order number	HS-Kopf / HS-head Bestell-Nr. / Order number	ø A min.	ø A max.	E	L	Wende- platte / Insert
279.020.010	278.347.006	5.3	10.6	20	27	CC..06 02..
279.020.010	278.317.006	8.3	13.6	20	27	CC..06 02..
279.020.010	278.277.006	12.3	17.6	20	27	CC..06 02..
279.020.010	278.247.006	15.3	20.6	20	27	CC..06 02..
279.020.010	278.217.006	18.3	23.6	20	27	CC..06 02..
279.020.010	278.197.006	20.3	25.6	20	27	CC..06 02..
279.020.010	278.177.006	22.3	27.6	20	27	CC..06 02..
279.020.010	278.167.006	23.3	28.6	20	27	CC..06 02..
279.030.010	278.347.006	25.3	30.6	30	27	CC..06 02..
279.030.010	278.317.006	28.3	33.6	30	27	CC..06 02..
279.030.010	278.277.006	32.3	37.6	30	27	CC..06 02..
279.030.010	278.247.006	35.3	40.6	30	27	CC..06 02..
279.030.010	278.217.006	38.3	43.6	30	27	CC..06 02..
279.030.010	278.197.006	40.3	45.6	30	27	CC..06 02..
279.030.010	278.177.006	42.3	47.6	30	27	CC..06 02..
279.030.010	278.167.006	43.3	48.6	30	27	CC..06 02..

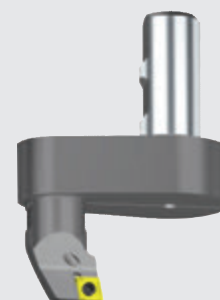

- die maximale Überdrehlänge L kann mit der Verlängerung 286.016.032 oder 286.016.064 verlängert werden
- Überdrehhalter und Kopf müssen separat bestellt werden
- **Achtung: Linkslauf**

- the maximal turning length L can be increased by extension 286.016.032 or 286.016.064
- pin turning adapter and head must be ordered separately
- **Caution: anticlockwise rotation**

## HS-Schaftverlängerungen

## HS-shank extensions

286

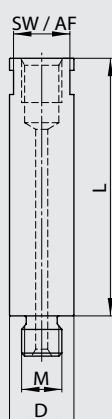

- zur Verlängerung von HS-Schäften und Überdrehhalter
- mit Innenkühlung
- aus gehärtetem Stahl

- to extend HS-shanks and pin turning adapter
- with inner coolant supply
- made of hardened steel

Bestell-Nr. / Order number	D	L	M	SW / AF
286.014.028	14	28	M 6	12
286.014.056	14	56	M 6	12
286.016.032	16	32	M10	14
286.016.064	16	64	M10	14



528

**Ausdrehset ø9.75-30.1**

**Fine boring set ø9.75-30.1**

• erweiterbar von ø3 bis ø88.1

• can be upgraded from ø3 up to ø88.1



Bestell-Nr. / Order number	D	ø A min.	ø A max.	L	L1	Ausdrehkopf / Fine boring head
<b>CAD 55 modular</b>						
528.000.030	55	9.75	30.1	53	50	260.550.053
<b>DIN 69893 HSK 63 A</b>						
528.063.030	55	9.75	30.1	95	70	269.063.095
<b>DIN 69871 AD 40</b>						
528.415.030	55	9.75	30.1	90	80	269.415.090
<b>MAS BT 40</b>						
528.412.030	55	9.75	30.1	90	80	269.412.090

Inhalt	Content	
1 Koffer / Case		
1 Ausdrehkopf / Fine boring head		
1 Ausdrehstahl / Boring bar	ø9.75-15.1	272.010.006
1 Ausdrehstahl / Boring bar	ø14.75-20.1	272.015.006
1 Ausdrehstahl / Boring bar	ø19.75-25.1	272.020.006
1 Ausdrehstahl / Boring bar	ø24.75-30.1	272.025.006
1 Inbusschlüssel / Allen wrench	SW5	
1 Torx-Schlüssel / Torx driver	T7	

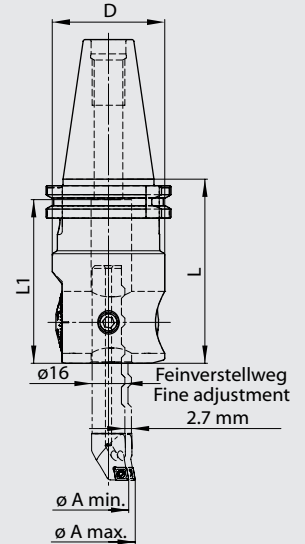

527

**Ausdrehset ø9.75-88.1**

**Fine boring set ø9.75-88.1**

• erweiterbar von ø3 bis ø88.1

• can be upgraded from ø3 up to ø88.1



Bestell-Nr. / Order number	D	ø A min.	ø A max.	L	L1	Ausdrehkopf / Fine boring head
<b>CAD 55 modular</b>						
527.000.088	55	9.75	88.1	53	50	260.550.053
<b>DIN 69893 HSK 63 A</b>						
527.063.088	55	9.75	88.1	95	70	269.063.095
<b>DIN 69871 AD 40</b>						
527.415.088	55	9.75	88.1	90	80	269.415.090
<b>MAS BT 40</b>						
527.412.088	55	9.75	88.1	90	80	269.412.090

Inhalt	Content	
1 Koffer / Case		
1 Ausdrehkopf / Fine boring head		
1 Ausdrehstahl / Boring bar	ø9.75-15.1	272.010.006
1 Ausdrehstahl / Boring bar	ø14.75-20.1	272.015.006
1 Ausdrehstahl / Boring bar	ø19.75-25.1	272.020.006
1 Ausdrehstahl / Boring bar	ø24.75-30.1	272.025.006
1 Schaft / shank	ø29.75-48.1	271.030.048
1 Schaft / shank	ø47.75-88.1	271.048.088
1 Wendeplattenhalter / Insert holder	ø29.75-48.1	253.030.006
1 Wendeplattenhalter / Insert holder	ø47.75-88.1	253.048.006
1 Inbusschlüssel / Allen wrench	SW4	
1 Inbusschlüssel / Allen wrench	SW5	
1 Torx-Schlüssel / Torx driver	T7	

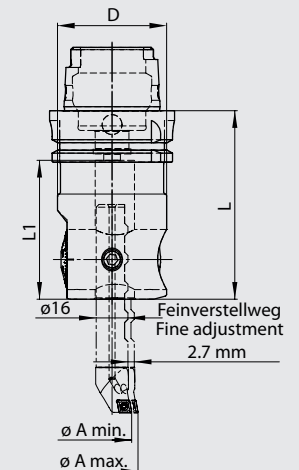

MULTI-  
HEAD

530

Ausdrehset  $\varnothing 9.75-164$

Fine boring set  $\varnothing 9.75-164$

• erweiterbar von  $\varnothing 3$  bis  $\varnothing 320$

• can be upgraded from  $\varnothing 3$  up to  $\varnothing 320$



Bestell-Nr. / Order number	D	$\varnothing A / \varnothing A1$ min.-max.	L	L1	L2	Ausdrehkopf / Fine boring head
<b>DIN 69893 HSK 63 A</b>						
530.063.164	63	9.75-164	96	72.5	125	263.063.095
<b>DIN 69871 AD 40</b>						
530.415.164	63	9.75-164	91	81	120	263.415.090
<b>MAS BT 40</b>						
530.412.164	63	9.75-164	91	81	120	263.412.090

**Inhalt**

**Content**

1 Koffer / Case						
1 Ausdrehkopf / Fine boring head						
1 Ausdrehstahl / Boring bar		$\varnothing 9.75-15.1$				272.010.006
1 Ausdrehstahl / Boring bar		$\varnothing 14.75-20.1$				272.015.006
1 Ausdrehstahl / Boring bar		$\varnothing 19.75-25.1$				272.020.006
1 Ausdrehstahl / Boring bar		$\varnothing 24.75-30.1$				272.025.006
1 Schaft / shank		$\varnothing 29.75-48.1$				271.030.048
1 Schaft / shank		$\varnothing 47.75-88.1$				271.048.088
1 Brücke / Bridge		$\varnothing 80$				886.086.164
1 Wendeplattenhalter / Insert holder		$\varnothing 29.75-48.1$				253.030.006
1 Wendeplattenhalter / Insert holder		$\varnothing 47.75-88.1$				253.048.006
1 Inbusschlüssel / Allen wrench		SW4				
1 Inbusschlüssel / Allen wrench		SW5				
1 Torx-Schlüssel / Torx driver		T7				

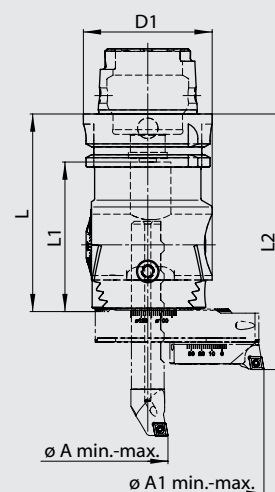

600

Wendeplatten

Inserts

Bestell-Nummer	Wendeplatte	Schneidstoff	Technische Informationen	Materialen	v [m/min]	f [mm/Z]
Order number	Insert	Cutting mat.	Technical information	Materials	v [m/min]	f [mm/r]
600.050.022	WCMT 020102	CTU	<b>Cermet-Wendeplatte</b> (Titan-Carbid / Titan-Nitrid) für Feinbohrarbeiten mit hoher Schnittgeschwindigkeit und gleichmässigem Aufmass.	Stahl Grauguss Aluminium	50–300 50–300 bis 800	0.04 bis 0.10
			Titanium carbide / titanium nitride ( <b>Cermet</b> ) for fine bore machining with high cutting speed and regular cutting depth.	Steel Cast Iron Aluminium	50–300 50–300 to 800	0.04 to 0.10
600.060.022	WCGT 020102	HUP	Unbeschichtete <b>Hartmetall-Wendeplatte</b> , allseitig geschliffen mit grossem Spanwinkel für Feinbohrarbeiten. Die Wendeplatte eignet sich insbesondere bei kleinem Aufmass und langen Bohrungen.	Stahl Stahl rostfrei Grauguss Aluminium	50–250 30–200 50–300 bis 800	0.04 bis 0.10
			Uncoated Carbide insert, ground all around with large rake angle for fine bore cutting. The insert is particularly good for small cutting depth in deep bores.	Steel Stainless steel Cast iron Aluminium	50–250 30–200 50–300 to 800	0.04 to 0.10
600.070.022	WCGT 020102	SFH	Mehrfach <b>beschichtete superfeinstkorn Hartmetall-Wendeplatte</b> zur Bearbeitung von harten und gehärteten Werkstoffen bis <b>62 HRC</b> . Die Wendeplatte eignet sich hervorragend für Feinbohrarbeiten in gehärtetem Stahl als Alternative zum K-Schleifen.	Stahl weich Stahl HRC 45 Stahl HRC 50 Stahl HRC 55 Stahl HRC 60 Stahl HRC 62	bis 300 80–250 80–200 50–150 30–100 20– 60	0.04 bis 0.20
600.070.024	WCGT 020104					
			Repeat <b>coated extremely fine grain carbide</b> insert for machining of hard and hardened steels up to <b>62 HRC</b> . Very suitable for fine boring of precision bores in hardened steel as an alternative to Jig-grinding.	Steel soft Steel HRC 45 Steel HRC 50 Steel HRC 55 Steel HRC 60 Steel HRC 62	bis 300 80–250 80–200 50–150 30–100 20– 60	0.04 to 0.20
600.200.062	CCMT 060202	CTU	<b>Cermet-Wendeplatte</b> (Titan-Carbid / Titan-Nitrid) für niedrige bis hohe Schnittgeschwindigkeiten beim Schlichten mit gleichbleibendem Aufmass. Auch für leichte Schrupperarbeiten einsetzbar. Bester Widerstand gegen Verschleiss und Schneidekantendeformation. Geeignet für Feinbohrarbeiten mit normalem Aufmass von 0.25 mm im Durchmesser.	Stahl Stahl rostfrei Grauguss Aluminium Buntmetall	50–300 30–250 50–300 bis 800 bis 500	0.08 bis 0.15
600.200.064	CCMT 060204					
600.200.092	CCMT 09T302					
600.200.094	CCMT 09T304					
600.200.098	CCMT 09T308					
600.200.128	CCMT 120408					
			Titanium carbide / titanium nitride ( <b>Cermet</b> ) for finishing with low to high cutting speeds with regular cutting depth. Also for light roughing. High resistance to wear and tip deformation. Suitable for fine boring with normal cutting depths from 0.25 mm in bored diameter.	Steel Stainless steel Cast iron Aluminium Copper alloys	50–300 30–250 50–300 to 800 to 500	0.08 to 0.15

HIT  
HRC+

Wendepplatten

Inserts

600

Bestell-Nummer	Wendepplatte	Schneidstoff	Technische Informationen	Materialen	v [m/min]	f [mm/Z]
Order number	Insert	Cutting mat.	Technical information	Materials	v [m/min]	f [mm/r]
600.300.062	CCGT 060202L ○		<p>Allseitig <b>geschliffene, hochpositive Cermet-Wendepplatte</b> (Titan-Carbid / Titan-Nitrid), für alle Feinbohrarbeiten. Die Wendepplatte eignet sich insbesondere bei kleinem Aufmass und langen Bohrungen. Durch den grossen Spanwinkel sind die Druck- und Schnittkräfte sehr gering.</p>	Stahl	50–300	0.06
600.300.064	CCGT 060204L ○			Stahl rostfrei	30–250	bis
600.300.092	CCGT 09T302L ○			Grauguss	50–250	0.12
600.300.094	CCGT 09T304L ○			Aluminium	bis 800	
				Buntmetall	bis 500	
			<p>All ground, <b>Cermet</b> insert with highly positive rake angle for all fine bore machining. Very suitable for deep bores with small cutting depth. Low cutting and pressing forces due to large rake angle.</p>	Steel	50–300	0.06
				Stainless steel	30–250	to
				Cast iron	50–250	0.12
				Aluminium	to 800	
				Copper alloys	to 500	
600.800.062	CCGT 060202L ○		<p>Mehrfach <b>beschichtete superfeinstkorn Hartmetall-Wendepplatte</b> zur Bearbeitung von harten und gehärteten Werkstoffen <b>bis 62 HRC</b>. Die Wendepplatte eignet sich hervorragend für Feinbohrarbeiten in gehärtetem Stahl als Alternative zum K-Schleifen.</p>	Stahl weich	bis 300	0.04
600.800.064	CCGT 060204L ○			Stahl HRC 45	80–250	bis
600.800.092	CCGT 09T302L ○			Stahl HRC 50	80–200	0.20
600.800.094	CCGT 09T304L ○			Stahl HRC 55	50–150	
				Stahl HRC 60	30–100	
				Stahl HRC 62	20– 60	
			<p>Repeat <b>coated extremely fine grain carbide</b> insert for machining of hard and hardened steels up to <b>62 HRC</b>. Very suitable for fine boring of precision bores in hardened steel as an alternative to Jig-grinding.</p>	Steel soft	bis 300	0.04
				Steel HRC 45	80–250	to
				Steel HRC 50	80–200	0.20
				Steel HRC 55	50–150	
				Steel HRC 60	30–100	
				Steel HRC 62	20– 60	
600.400.064	CCMT 060204 ●		<p>Mehrfach <b>beschichtete Hartmetall-Wendepplatte</b> mit hoher Verschleissfestigkeit und grossem Widerstand gegen plastische Verformung. Generell geeignet für die Stahlbearbeitung mit mittleren bis hohen Schnittgeschwindigkeiten.</p>	Stahl	20–280	0.10
600.400.094	CCMT 09T304 ●			Stahl rostfrei	30–250	bis
600.400.098	CCMT 09T308 ●			Grauguss	50–250	0.40
600.401.128	CCMT 1204.08 ●			Sphäroguss	50–180	
600.400.128	CNMG 120408 ●			Aluminium	bis 800	
600.400.168	CNMG 160608 ●			Buntmetall	bis 500	
600.400.169	CNMG 160612 ●					
600.400.198	CNMG 190612 ●					
600.400.199	CNMG 190616 ●					
					<p>Repeat <b>coated carbide</b> insert with high wear and plastic deformation resistance. Generally used for machining of ferrous steels with middle to high cutting speeds.</p>	Steel
				Stainless steel	30–250	to
				Cast iron	50–250	0.40
				Spheroidal cast iron	50–180	
				Aluminium	to 800	
				Copper alloys	to 500	
600.500.128	CNMM 120408 ●		<p>Mehrfach <b>beschichtete Hartmetall-Wendepplatte</b> mit höchster Zähigkeit und Stabilität der Schneidekante. Geeignet für Stahlbearbeitung durch die positive Schneidegeometrie auch bei unterbrochenem Schnitt.</p>	Stahl	50–300	0.10
600.500.168	CNMM 160608 ●			Stahl rostfrei	30–250	bis
600.500.169	CNMM 160612 ●			Grauguss	50–300	0.60
600.500.198	CNMM 190612 ●			Sphäroguss	50–200	
600.500.199	CNMM 190616 ●			Aluminium	bis 800	
				Buntmetall	bis 500	
			<p>Repeat <b>coated carbide</b> insert, very tough with high stability cutting edge. Suitable for machining of ferrous steels also with interrupted cut due to its positive cutting geometry.</p>	Steel	50–300	0.10
				Stainless steel	30–250	to
				Cast iron	50–300	0.60
				Spheroidal cast iron	50–200	
				Aluminium	to 800	
				Copper alloys	to 500	



**SWISS**  **TOOLS**

Swiss Tool Systems AG

Wydenstrasse 28

CH-8575 Bürglen

Phone +41 (0)71 634 85 20

Fax +41 (0)71 634 85 29

[www.swisstools.org](http://www.swisstools.org)