

**FOCUS ON INDIVIDUAL SOLUTIONS**

# SOLUTIONS

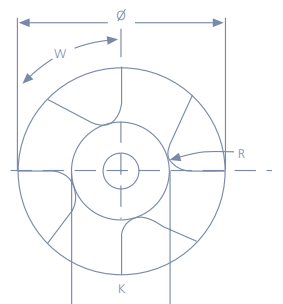
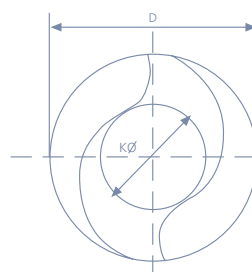
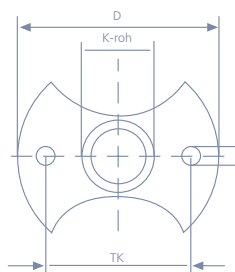

# CONVINCINGLY VISIONARY

# VISIONARY

**AFC is located in Mainleus in Upper Franconia, only a stone's throw from Bayreuth and about 100 km from Nuremberg. Our company may be young, but the solutions which we create are mature and visionary. You can see for yourself with the information on the following pages. You are also very welcome to visit us personally at our plant.**

## **Absolutely dynamic**

Since the founding of our company in 1999 and the beginning of production in the following year, a lot has been accomplished. These figures say everything:

At the beginning, we manufactured about 8 t carbide a month with 27 employees. Today, after expanding our operation three times, our monthly capacity has already risen to over 60 t carbide and our annual manufacturing capacity is estimated at about 1000 t. Our greatest capital? Our workforce which has grown to over 115 employees in the meantime. They are dedicated and work on our dynamic development. Successfully.





### Simply innovative

It can be seen time and again that simple ideas are often the best: Our patented process for the manufacturing of our “specialty” – carbide rods with spiral cooling ducts – is based on such an idea.



### Multiply talent

Highly specialized products require highly qualified know-how, which we have: Many of our employees can look back on more than ten years of professional experience in the manufacturing of carbides. Dedicated engineers and specialists work together with master craftsmen for the further development of our products and services. A profitable potential which pays off for you. In problem solutions which meet your requirements perfectly.

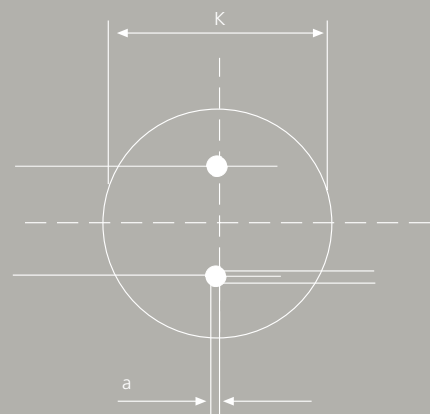

# SERVICES FOR YOUR SATISFACTION

# SATISFAC

## Limitlessly service-oriented

Our customers are located everywhere in the world and especially where great things are to be accomplished. AFC is the right partner for them as our service knows no limits. As an independent, medium-sized company, we can examine and react quickly and flexibly to customers' individual requirements. We advise and support you in a partnership to produce exactly the right economical solution individually for you. This is how we understand customer satisfaction – cooperation which satisfies – and nothing else.





# TION



## Our offer: VHM for tools with rising requirements

- VHM round rods without cooling ducts in different designs
- VHM round rods with cooling ducts in different designs:
  - One, two, three or on request more cooling ducts
  - Straight or spiral
  - Round, oval or special cooling duct shapes on request
  - Boring in the shank
  - Adapted outlet at the head
- Micro drills and gun drills
- Fixed length
- Pre-slotted rods
- Machining of the ends
- Ground rods

Is there something more we can do? Then, just tell us! We will fulfill your requirements in carbides.

# CERTIFICATES CONFIRM OUR COMPETENCE

ZERTIFIKAT ♦ CERTIFICATE ♦ 認證證書 ♦ CERTIFICADO ♦ CERTIFICAT



TUV  
SUD  
Management Service

## CERTIFICATE

The Certification Body  
of TÜV SÜD Management Service GmbH  
certifies that



**Arno Friedrichs Hartmetall  
GmbH & Co. KG**  
Burgkunstadter Straße 7  
D-95336 Mainleus

has established and applies  
a Quality Management System for

**Production, Development and  
Sales of Carbide**

An audit was performed, Report No. **70010876**  
Proof has been furnished that the requirements  
according to

**ISO 9001: 2000**

are fulfilled. The certificate is valid until **2009-09-05**  
Certificate Registration No. **12 100 14787 TMS**

  
Munich, 2009-09-25

  
QMS-TGA-ZM-07-02

TÜV SÜD Management Service GmbH • Zertifizierstelle • Riderstraße 65 • 88339 München • Germany

ZERTIFIKAT ♦ CERTIFICATE ♦ 認證證書 ♦ CERTIFICADO ♦ CERTIFICAT



TUV  
SUD  
Management Service

## CERTIFICATE

The Certification Body  
of TÜV SÜD Management Service GmbH  
certifies that



**Arno Friedrichs Hartmetall  
GmbH & Co. KG**  
Burgkunstadter Straße 7  
D-95336 Mainleus

has established and applies  
an Environmental Management System for

**Production, Development and  
Sales of Carbide**

An audit was performed, Report No. **70010876**  
Proof has been furnished that the requirements  
according to

**ISO 14001: 2004**

are fulfilled. The certificate is valid until **2009-09-05**  
Certificate Registration No. **12 104 14787 TMS**

  
Munich, 2009-09-25

  
EMS-TGA-ZM-07-02

TÜV SÜD Management Service GmbH • Zertifizierstelle • Riderstraße 65 • 88339 München • Germany

# COMPE

# TENGE

## Certified for top quality

Our certification in compliance with DIN EN ISO 9001:2000 stands for transparent structures, traceable working processes and continuous controls. On the whole, for consistent quality on a high level when it comes to the development, manufacturing and sale of carbides. Our strict concentration on the top quality of our services helps us to demonstrate our competence to our customers – as a living promise which we keep. Today and tomorrow.

## Certified in the service of our environment

Our certification in compliance with DIN EN ISO 14001:2004 shows our efforts for sustainable operation in the service of our environment and our care for following generations. We do everything within our power to minimize the risks for our environment, our workforce, our customers and our ability to supply.

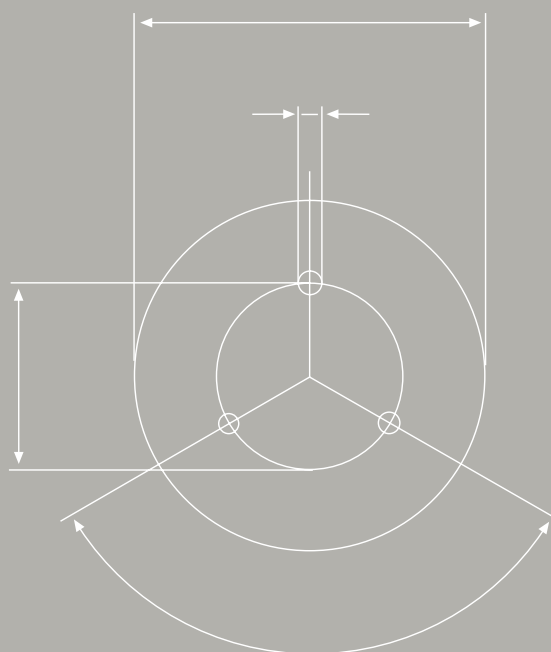

# THINGS WORTH KNOWING ABOUT CARBIDE

# CARBI



## Advantageous – for good reasons

Carbides essentially consist of two components:

- The carbide material (WC)
- The binder material (Co).

The carbide owes its extremely high hardness to the carbide material and its high toughness to the binder metal. The result of this is the carbide's advantage in comparison with steel and in comparison with high speed steel as well. Steel owes its high hardness to a phase which is produced during quenching, but which always breaks down into stable, but softer phases during annealing. On the other hand, carbide consists mostly of a natural, stable phase which practically never loses its hardness through heating. Their extremely high hardness and the outstanding thermal stability are the reasons why carbide tools provide significantly longer service lives than HSS tools.

## Manufacturing of raw carbide – always profitable

The starting materials for carbides are WC and Co powder which are mixed thoroughly with each other and kneaded into a plastic mass which can be extruded in rod form on extrusion presses. Before sintering, the heat treatment which produces their strength, the dried blanks can be processed in many different ways in their form, through which there is ample opportunity to meet customer requirements. This saves the customer a working step while we can reuse the cut material again in our process.







# DES

## Our motto – highest quality

The quality of the powder used determines the quality of the carbide – so the use of only the best raw materials is our motto. We guarantee this through close cooperation with our suppliers who always customize their materials for our products.

## Carbides are entirely individual

To manufacture carbide which can satisfy your requirements, we have two possibilities to influence their characteristics:

- Either, we vary the grain size of the WC raw powder
- Or, we vary the WC/Co ratio.

A distinction is made between very fine, ultra fine and super fine grain sizes. With increasing fineness of the grain size, the hardness and bending strength grow, but the toughness declines. If we increase the proportion of the Co in the carbide, the toughness and bending resistance increase, but the hardness declines. Our extensive experience in powder manufacturing, in shaping and in sintering is your guarantee that the carbide you select from our range will also be convincing with its homogeneous characteristics.

We will be pleased to advise you with the selection of the optimum carbide for your needs.

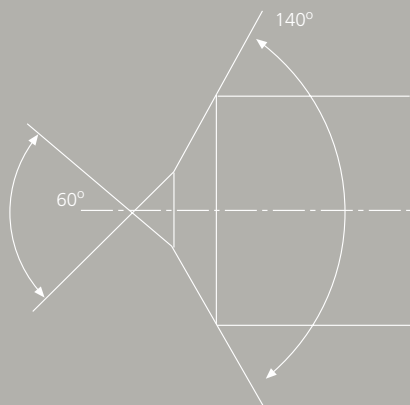

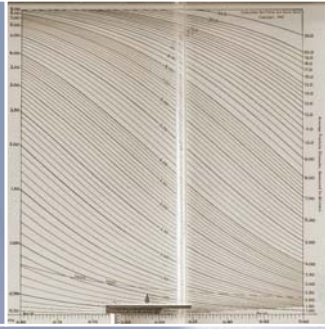

## AF K10 UF

<b>ISO-Range</b>	: K10
<b>Chemical data</b>	
Co (%)	: 6
WC incl. Doping (%)	: 94
<b>Physical Data</b>	
Density (g/cm <sup>3</sup> )	: 14,8
Hardness	
HV 30 (N/mm <sup>2</sup> )	: 1900
HRA	: 93,8
Transverse Rupture Strength (N/mm <sup>2</sup> )	: >3500
<b>Metallographic Data</b>	
Porosity	
≤10 μm A	: ≤02
10-25 μm B	: 00
C	: 00
Microstructure	
Tungsten Carbide α	: Ø 0,6 μm
Binding Phase β	: unif. distr.
Mixed carbide γ	: -
Eta Phase η	: -
<b>Areas of Application</b>	
Grey cast iron	
Unalloyed steels	
Plastics	
<b>Microstructure</b>	
Murakami-Etching	

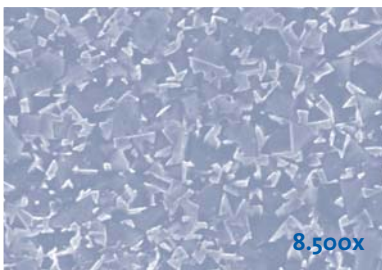

## AF K20 CF

<b>ISO-Range</b>	: K10 - K20
<b>Chemical data</b>	
Co (%)	: 8
WC incl. Doping (%)	: 92
<b>Physical Data</b>	
Density (g/cm <sup>3</sup> )	: 14,6
Hardness	
HV 30 (N/mm <sup>2</sup> )	: 1710
HRA	: 92,5
Transverse Rupture Strength (N/mm <sup>2</sup> )	: >3200
<b>Metallographic Data</b>	
Porosity	
<10 μm A	: ≤02
>10 μm B	: 00
C	: 00
Microstructure	
Tungsten Carbide α	: Ø 0,7 μm
Binding Phase β	: unif. distr.
Mixed carbide γ	: -
Eta Phase η	: -
<b>Areas of Application</b>	
Grey cast iron	
Unalloyed steels	
<b>Microstructure</b>	
Murakami-Etching	

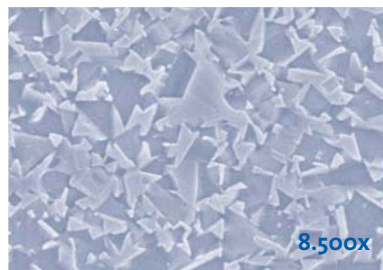

## AF K34 EF

<b>ISO-Range</b>	: K20 - K30
<b>Chemical data</b>	
Co (%)	: 9
WC incl. Doping (%)	: 91
<b>Physical Data</b>	
Density (g/cm <sup>3</sup> )	: 14,3
Hardness	
HV 30 (N/mm <sup>2</sup> )	: 1930
HRA	: 94,0
Transverse Rupture Strength (N/mm <sup>2</sup> )	: >3900
<b>Metallographic Data</b>	
Porosity	
<10 μm A	: ≤02
>10 μm B	: 00
C	: 00
Microstructure	
Tungsten Carbide α	: Ø <0,5 μm
Binding Phase β	: unif. distr.
Mixed carbide γ	: -
Eta Phase η	: -
<b>Areas of Application</b>	
Grey cast iron	
Unalloyed steels	
Aluminium alloys	
Plastics	
Fibre reinforced materials	
<b>Microstructure</b>	
Murakami-Etching	

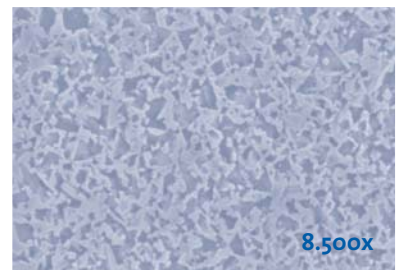

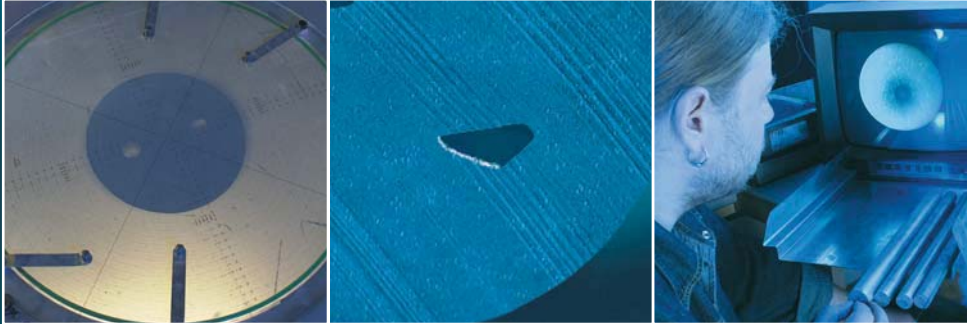

## AF K40 UF

■ ISO-Range : K30 - K40

### ■ Chemical data

Co (%) : 10  
WC incl. Doping (%) : 90

### ■ Physical Data

Density (g/cm<sup>3</sup>) : 14,5  
Hardness  
HV 30 (N/mm<sup>2</sup>) : 1610  
HRA : 91,9  
Transverse Rupture Strength  
(N/mm<sup>2</sup>) : >3600

### ■ Metallographic Data

Porosity  
<10 μm A : ≤02  
>10 μm B : 00  
C : 00

### Microstructure

Tungsten Carbide α : Ø 0,6 μm  
Binding Phase β : unif. distr.  
Mixed carbide γ : -  
Eta Phase η : -

### ■ Areas of Application

Corrosion and heat resistant steels  
Stainless steels  
Non ferrous metals  
Plastics

### ■ Microstructure

Murakami-Etching

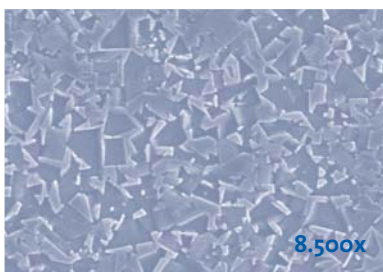

8.500x

## AF K44 EF

■ ISO-Range : K40 - K50

### ■ Chemical data

Co (%) : 12  
WC incl. Doping (%) : 88

### ■ Physical Data

Density (g/cm<sup>3</sup>) : 14,1  
Hardness  
HV 30 (N/mm<sup>2</sup>) : 1680  
HRA : 92,3  
Transverse Rupture Strength  
(N/mm<sup>2</sup>) : >3800

### ■ Metallographic Data

Porosity  
<10 μm A : ≤02  
>10 μm B : 00  
C : 00

### Microstructure

Tungsten Carbide α : Ø 0,5 μm  
Binding Phase β : unif. distr.  
Mixed carbide γ : -  
Eta Phase η : -

### ■ Areas of Application

Corrosion and heat resistant steels  
Stainless steels  
Titanium alloys  
Non ferrous metals

### ■ Microstructure

Murakami-Etching

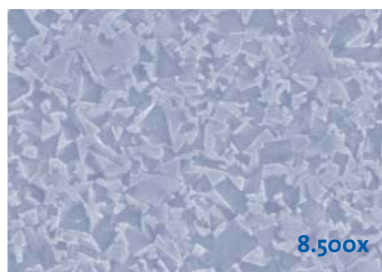

8.500x

## AF K45 EF

■ ISO-Range : K40 - K50

### ■ Chemical data

Co (%) : 13  
WC incl. Doping (%) : 87

### ■ Physical Data

Density (g/cm<sup>3</sup>) : 13,9  
Hardness  
HV 30 (N/mm<sup>2</sup>) : 1700  
HRA : 92,4  
Transverse Rupture Strength  
(N/mm<sup>2</sup>) : >3900

### ■ Metallographic Data

Porosity  
<10 μm A : ≤02  
>10 μm B : 00  
C : 00

### Microstructure

Tungsten Carbide α : Ø <0,5 μm  
Binding Phase β : unif. distr.  
Mixed carbide γ : -  
Eta Phase η : -

### ■ Areas of Application

Corrosion and heat resistant steels  
Stainless steels  
Titanium alloys  
Non ferrous metals

### ■ Microstructure

Murakami-Etching



8.500x

# DUPLO- TOOLS OF THE FUTURE

## TOOLS

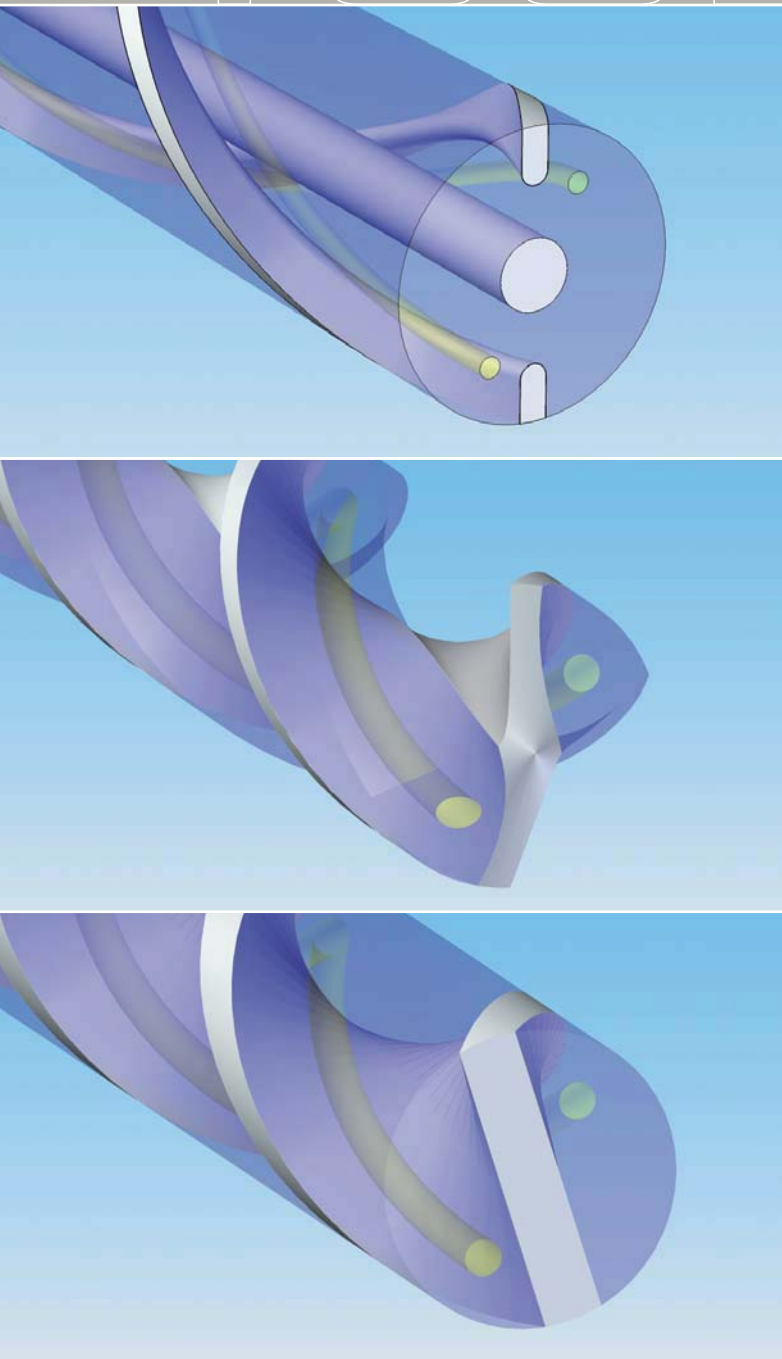

### Hard shell – tough core

Not a contradiction, but twice as good: this describes the new tools from AFC very exactly. Because a hard shell and a tough core are united as a perfect whole in one and the same tool.

This is made possible on the carrier in the inside, consisting of a large grain, tough material and the outer skin as a fine grain, very hard type. We at AFC have developed a patented process with which we can apply the hard material on any desired place on the carrier with our tools.

This is a way to circumvent the problem that hardness and toughness can be combined only at the expense of each other. Through the tough carrier material, the AFC process creates high toughness and at the same time very high lifetime through the hardness of the outer skin. In brief – Duplo are your tools of the future.

Toughness and hardness combined – benefit from Duplo!



# NEW APPROACH FOR QUALIFIED CUSTOMER ADVICE

## Complete manufacturing line for test tools

Customer service and top quality have the highest priority for AFC. To guarantee this at all times, we have equipped a tool laboratory to the latest state-of-the-art of technology. Our customers benefit from optimum recommendations and individual advice.

To fulfill every customer request, our new tool laboratory has a complete manufacturing line. For grinding the reverse side of the carbide blanks as well as the ends, we have a tipless and cylindrical grinding machine available. For manufacturing tools, we invested a short time ago in a universal grinding machine.

AFC has excellent measuring instruments for the evaluation of cut edge properties. In addition, we work together with independent university facilities which test our tools thoroughly for the highest quality. This lets us guarantee you the highest reliable quality.

When it comes to coating tools, quality is always the first consideration at AFC. In this area, we work closely together exclusively with well-known companies in this sector.

## Development of types for specific applications

In this way, we can make valuable recommendations for pending applications well in advance. The fine tuning of the carbide quality and the individual consulting for the use of the tool in your plant are brought together in one place with us.

Our customers benefit from shorter development times for new grades and tools.

Since it was founded, AFC has worked intensively with the research and development of high quality grades. To improve tool quality even further, the development of the appropriate grade is not coupled directly with the specific application at AFC. Our objective is always to optimize our tools in the context of research and development projects with our customers.



# VISIT OUR WEB SHOP

WWW.ECARBIDE.DE



## Order sample

grade: AF K20 CF xxx.78.xxx  
 AF K34 EF xxx.49.xxx  
 AF K40 UF xxx.70.xxx  
 AF K44 EF xxx.62.xxx

Artikelnr.	D [mm]	+ Tol	Dh6 [mm]	Bohr.Ø	+ Tol	L+10 [mm]	Artikel Nr.	Artikel Nr.
	4,3	+0,3	4,0	0,6	±0,10	330	xxx.xx.043	xxx.xx.040-h6
	6,3	+0,3	6,0	1,0	±0,15	330	xxx.xx.063	xxx.xx.060-h6
		+0,3	8,8	1,3	±0,15	330	xxx.xx.083	xxx.xx.080-h6
		+0,4	10,0	2,0	±0,20	330	xxx.xx.103	xxx.xx.100-h6
					±0,20	330	xxx.xx.123	xxx.xx.120-h6
							xxx.xx.143	xxx.xx.140-h6
								xxx.160-h6

**103.70.063**

LECOTHAC™ ASVR

- Diameter (Ø mm x 10)
- Carbide grade  
(78=AF K20 CF, 49=AF K34 EF, 70=AF K40 UF, 62=AF K44 EF, 53=AF K45 EF, 35=AF K50 SF)
- Length (3=330 mm)
- Pitch (3=30°, 4=40°)
- No. of cooling channels (0, 1, 2, 3)

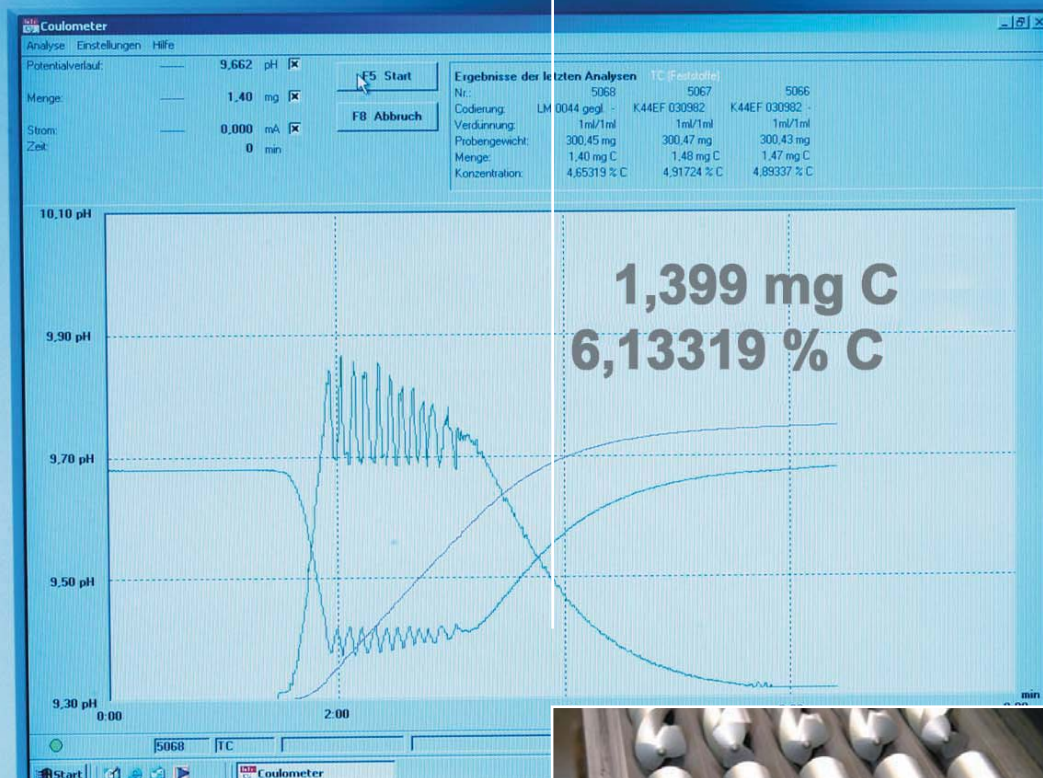

### Designed for convenience

We are always available for our customers and interested parties because we offer our products around the clock in our Online Shop, independent of time zones and distances. Are you looking for a special product? Simply enter the product name and you will find it very quickly. Even if you see an alternative in other carbide grades and lengths.

In this case, simply use the selection field to choose geometrical characteristics and limit the diameter range. You will soon have the appropriate product solutions available.

At best, register right now and test the advantages of our shop without delay – we're looking forward to your virtual visit!

**You can find our shop under**  
**[www.ecarbide.de](http://www.ecarbide.de)**

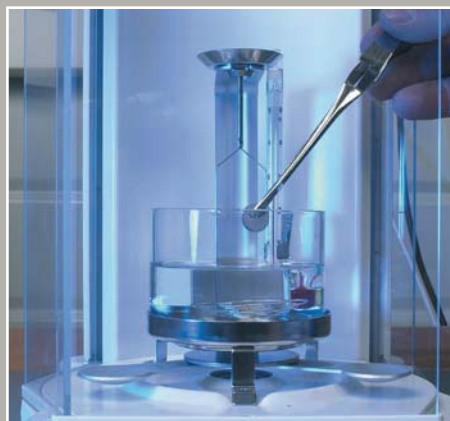
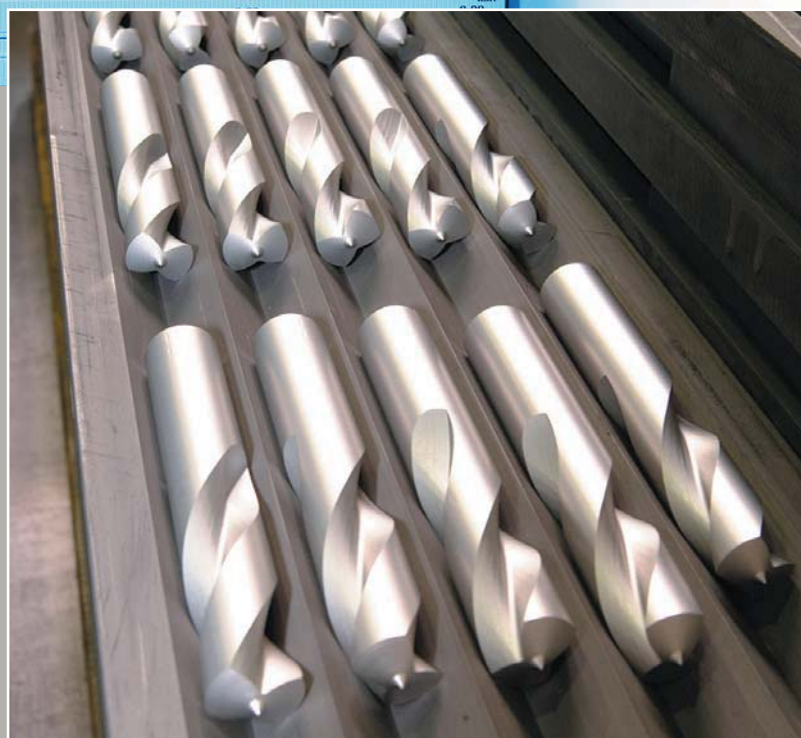

## OUR GRINDING SHOP



### Your wish is our inspiration

Our in-house grinding shop offers you finished ground rods to meet various requests. Our customers accept this offer with great interest and benefit from the substantial increase in our grinding capacities.

### Guaranteed professional competence

Our grinding shop is headed by an experienced expert who specializes in the process of centerless grinding. Our products comply with the diameter tolerances of DIN ISO 286/h6 and the surface roughness  $Ra < 0.06 \mu\text{m}$  polished finish. On request, other diameters and tolerances are possible.

# GRINDI





# NG SHARP



## Everything from a single source

Raw carbide manufacturing including grinding from a single source means that you receive blanks from us that are already ground to the shaft diameter. You only have to complete the final grinding. We guarantee the highest precision and documented quality.

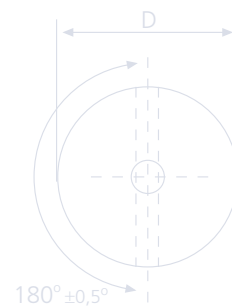

## Last, but not least

We also cut rods to length and bevel them for you. The situation with cutting rods to length is similar to the one with grinding. In this area as well, customer interest has moved us to extend our capacity significantly.

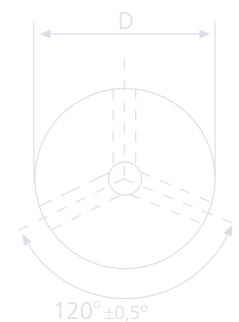

Furthermore, we are in the position to provide the blanks with bevels on new fully automatic beveling machines to meet customer requirements.

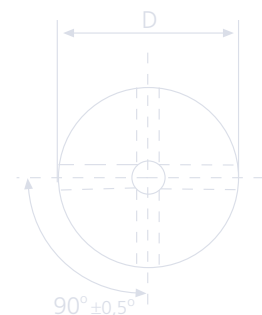

## solid rods

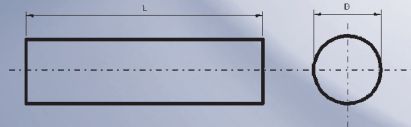

## grade:

<i>AF K10 UF</i>	xxx.66.xxx	<i>AF K40 UF</i>	xxx.70.xxx
<i>AF K20 CF</i>	xxx.78.xxx	<i>AF K44 EF</i>	xxx.62.xxx
<i>AF K34 EF</i>	xxx.49.xxx	<i>AF K45 EF</i>	xxx.53.xxx

article no.		oo3.xx.xxx			
dia.[mm]	+Tol	dia.h6 [mm]	L+10 [mm]	article no.	article no.
1,2	+0,2		330	xxx.xx.012	
1,7	+0,2		330	xxx.xx.017	
2,2	+0,2		330	xxx.xx.022	
2,7	+0,2		330	xxx.xx.027	
3,2	+0,2	3,0	330	xxx.xx.032	xxx.xx.030-h6
3,7	+0,2		330	xxx.xx.037	
4,2	+0,2	4,0	330	xxx.xx.042	xxx.xx.040-h6
4,7	+0,2		330	xxx.xx.047	
5,2	+0,2	5,0	330	xxx.xx.052	xxx.xx.050-h6
5,7	+0,2		330	xxx.xx.057	
6,2	+0,2	6,0	330	xxx.xx.062	xxx.xx.060-h6
6,7	+0,2		330	xxx.xx.067	
7,2	+0,2		330	xxx.xx.072	
7,7	+0,2		330	xxx.xx.077	
8,2	+0,3	8,0	330	xxx.xx.082	xxx.xx.080-h6
8,7	+0,3		330	xxx.xx.087	
9,2	+0,3		330	xxx.xx.092	
9,7	+0,3		330	xxx.xx.097	
10,2	+0,3	10,0	330	xxx.xx.102	xxx.xx.100-h6
10,7	+0,3		330	xxx.xx.107	
11,2	+0,3		330	xxx.xx.112	
11,7	+0,3		330	xxx.xx.117	
12,2	+0,3	12,0	330	xxx.xx.122	xxx.xx.120-h6
12,7	+0,3		330	xxx.xx.127	
13,2	+0,3		330	xxx.xx.132	
13,7	+0,3		330	xxx.xx.137	
14,2	+0,3	14,0	330	xxx.xx.142	xxx.xx.140-h6
14,7	+0,3		330	xxx.xx.147	
15,2	+0,3		330	xxx.xx.152	
15,7	+0,3		330	xxx.xx.157	
16,2	+0,4	16,0	330	xxx.xx.162	xxx.xx.160-h6
16,7	+0,4		330	xxx.xx.167	
17,2	+0,4		330	xxx.xx.172	
17,7	+0,4		330	xxx.xx.177	
18,2	+0,4		330	xxx.xx.182	
18,7	+0,4		330	xxx.xx.187	
19,2	+0,4		330	xxx.xx.192	
19,7	+0,4		330	xxx.xx.197	
20,2	+0,5	20,0	330	xxx.xx.202	xxx.xx.200-h6
20,7	+0,5		330	xxx.xx.207	
21,2	+0,5		330	xxx.xx.212	
21,7	+0,5		330	xxx.xx.217	
22,2	+0,5		330	xxx.xx.222	
22,7	+0,5		330	xxx.xx.227	
23,2	+0,5		330	xxx.xx.232	
23,7	+0,5		330	xxx.xx.237	
24,2	+0,5		330	xxx.xx.242	

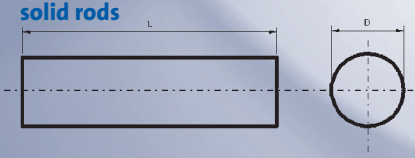
solid rods			grade:		
			<b>AF K10 UF</b> xxx.66.xxx <b>AF K40 UF</b> xxx.70.xxx <b>AF K20 CF</b> xxx.78.xxx <b>AF K44 EF</b> xxx.62.xxx <b>AF K34 EF</b> xxx.49.xxx <b>AF K45 EF</b> xxx.53.xxx		
article no.			003.xx.xxx		
dia. [mm]	+Tol	dia.h6 [mm]	L+10 [mm]	article no.	article no.
25,2	+0,5	25,0	330	xxx.xx.252	xxx.xx.250-h6
26,2	+0,5		330	xxx.xx.262	
27,2	+0,5		330	xxx.xx.272	
28,2	+0,5		330	xxx.xx.282	
29,2	+0,5		330	xxx.xx.292	
30,2	+0,5		330	xxx.xx.302	
31,2	+0,5		330	xxx.xx.312	
32,2	+0,5		330	xxx.xx.322	
33,2	+0,5		330	xxx.xx.332	
34,2	+0,5		330	xxx.xx.342	
35,2	+0,5		330	xxx.xx.352	

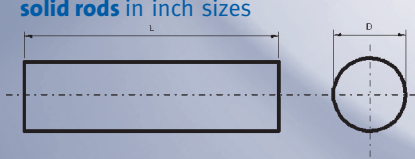
solid rods in inch sizes			grade:			
			<b>AF K10 UF</b> xxx.66.xxx <b>AF K40 UF</b> xxx.70.xxx <b>AF K20 CF</b> xxx.78.xxx <b>AF K44 EF</b> xxx.62.xxx <b>AF K34 EF</b> xxx.49.xxx <b>AF K45 EF</b> xxx.53.xxx			
article no.			003.xx.xxx			
dia.[inch]	dia.[mm]	+ Tol	dia. h6 [mm]	L+10 [mm]	article no.	article no.
1/16	1,8	+0,2	1,5875	330	xxx.xx.018	xxx.xx.001-16
1/8	3,4	+0,2	3,1750	330	xxx.xx.034	xxx.xx.001-08
3/16	5,0	+0,2	4,7625	330	xxx.xx.050	xxx.xx.003-16
1/4	6,6	+0,2	6,3500	330	xxx.xx.066	xxx.xx.001-04
5/16	8,2	+0,3	7,9375	330	xxx.xx.082	xxx.xx.005-16
3/8	9,7	+0,3	9,5250	330	xxx.xx.097	xxx.xx.003-08
7/16	11,3	+0,3	11,1125	330	xxx.xx.113	xxx.xx.007-16
1/2	12,9	+0,3	12,7000	330	xxx.xx.129	xxx.xx.001-02
9/16	14,5	+0,3	14,2875	330	xxx.xx.145	xxx.xx.009-16
5/8	16,1	+0,4	15,8750	330	xxx.xx.161	xxx.xx.005-08
11/16	17,7	+0,4	17,4625	330	xxx.xx.177	xxx.xx.011-16
3/4	19,3	+0,4	19,0500	330	xxx.xx.193	xxx.xx.003-04
13/16	20,9	+0,5	20,6375	330	xxx.xx.209	xxx.xx.013-16
7/8	22,5	+0,5	22,2250	330	xxx.xx.225	xxx.xx.007-08
15/16	24,2	+0,5	23,8125	330	xxx.xx.242	xxx.xx.015-16
1	25,7	+0,5	25,4000	330	xxx.xx.257	xxx.xx.001-00

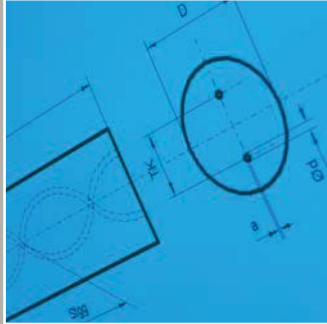

rods with central hole				grade:		
				AF K10 UF    xxx.66.xxx AF K20 CF    xxx.78.xxx AF K34 EF    xxx.49.xxx AF K40 UF    xxx.70.xxx AF K44 EF    xxx.62.xxx		
article no.				103.xx.xxx		
dia.[mm]	+ Tol	dia.h6 [mm]	hole Ø ± Tol	L+10 [mm]	article no.	article no.
4,3	+0,3	4,0	0,6 ±0,10	330	xxx.xx.043	xxx.xx.040-h6
6,3	+0,3	6,0	1,0 ±0,15	330	xxx.xx.063	xxx.xx.060-h6
8,3	+0,3	8,0	1,3 ±0,15	330	xxx.xx.083	xxx.xx.080-h6
10,3	+0,4	10,0	2,0 ±0,20	330	xxx.xx.103	xxx.xx.100-h6
12,3	+0,4	12,0	2,0 ±0,20	330	xxx.xx.123	xxx.xx.120-h6
14,3	+0,4	14,0	2,0 ±0,20	330	xxx.xx.143	xxx.xx.140-h6
16,3	+0,5	16,0	2,0 ±0,20	330	xxx.xx.163	xxx.xx.160-h6
18,3	+0,5	18,0	3,0 ±0,25	330	xxx.xx.183	xxx.xx.180-h6
20,3	+0,5	20,0	3,0 ±0,25	330	xxx.xx.203	xxx.xx.200-h6
22,3	+0,5	22,0	3,0 ±0,25	330	xxx.xx.223	xxx.xx.220-h6
24,3	+0,5	24,0	4,0 ±0,30	330	xxx.xx.243	xxx.xx.240-h6
26,3	+0,5	26,0	4,0 ±0,30	330	xxx.xx.263	xxx.xx.260-h6
28,3	+0,5	28,0	4,0 ±0,30	330	xxx.xx.283	xxx.xx.280-h6
30,3	+0,5	30,0	5,0 ±0,35	330	xxx.xx.303	xxx.xx.300-h6
32,3	+0,5	32,0	5,0 ±0,35	330	xxx.xx.323	xxx.xx.320-h6

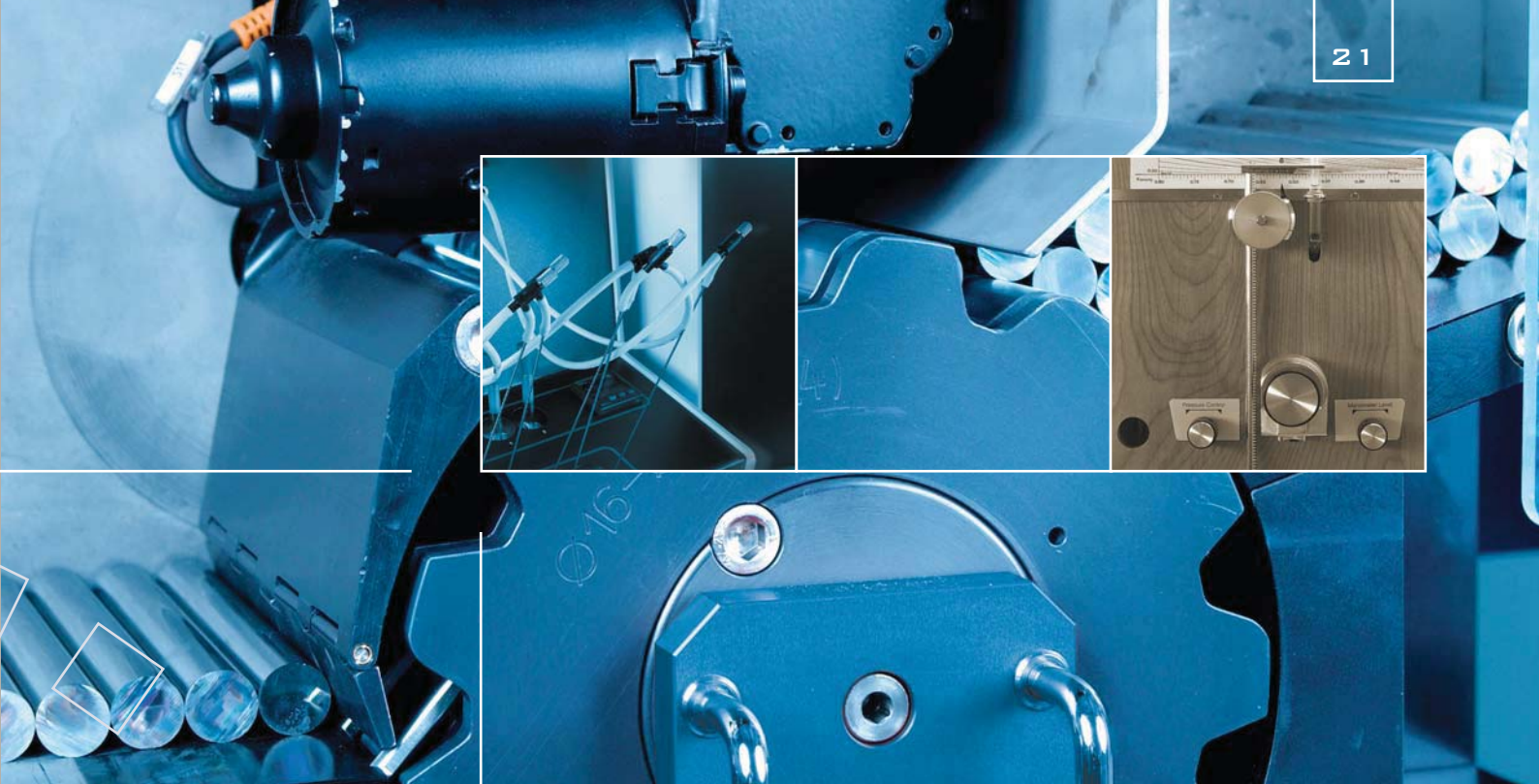

parallel holes with standard bolt circle

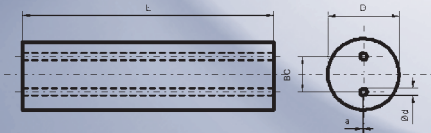

grade:

**AF K10 UF** xxx.66.xxx  
**AF K20 CF** xxx.78.xxx  
**AF K34 EF** xxx.49.xxx

**AF K40 UF** xxx.70.xxx  
**AF K44 EF** xxx.62.xxx

article no.							203.xx.xxx		
dia.[mm] + Tol	dia.h6 [mm]	BC	±Tol	hole Ø	±Tol	a	L +10[mm]	article no.	article no.
4,2	+0,30	4,0	1,72 ±0,08	0,80	±0,10	0,10	330	xxx.xx.042	xxx.xx.040-h6
5,2	+0,30	5,0	1,92 ±0,08	0,80	±0,10	0,13	330	xxx.xx.052	xxx.xx.050-h6
6,3	+0,30	6,0	2,90 ±0,10	1,00	±0,10	0,15	330	xxx.xx.063	xxx.xx.060-h6
7,3	+0,30	7,0	3,40 ±0,10	1,00	±0,15	0,15	330	xxx.xx.073	xxx.xx.070-h6
8,3	+0,30	8,0	3,85 ±0,15	1,00	±0,15	0,15	330	xxx.xx.083	xxx.xx.080-h6
9,3	+0,30	9,0	3,85 ±0,15	1,40	±0,15	0,20	330	xxx.xx.093	xxx.xx.090-h6
10,3	+0,30	10,0	4,85 ±0,15	1,40	±0,15	0,20	330	xxx.xx.103	xxx.xx.100-h6
11,3	+0,40	11,0	4,85 ±0,15	1,40	±0,15	0,28	330	xxx.xx.113	xxx.xx.110-h6
12,3	+0,40	12,0	5,85 ±0,15	1,75	±0,15	0,30	330	xxx.xx.123	xxx.xx.120-h6
13,3	+0,40	13,0	5,85 ±0,15	1,75	±0,15	0,34	330	xxx.xx.133	xxx.xx.130-h6
14,3	+0,40	14,0	6,85 ±0,15	1,75	±0,15	0,37	330	xxx.xx.143	xxx.xx.140-h6
15,3	+0,40	15,0	6,85 ±0,15	2,00	±0,20	0,40	330	xxx.xx.153	xxx.xx.150-h6
16,3	+0,40	16,0	7,85 ±0,15	2,00	±0,20	0,40	330	xxx.xx.163	xxx.xx.160-h6
17,3	+0,50	17,0	7,85 ±0,15	2,00	±0,20	0,47	330	xxx.xx.173	xxx.xx.170-h6
18,3	+0,50	18,0	8,85 ±0,15	2,00	±0,20	0,50	330	xxx.xx.183	xxx.xx.180-h6
19,3	+0,50	19,0	8,85 ±0,15	2,00	±0,20	0,50	330	xxx.xx.193	xxx.xx.190-h6
20,4	+0,50	20,0	9,80 ±0,20	2,50	±0,25	0,50	330	xxx.xx.204	xxx.xx.200-h6
21,4	+0,50	21,0	9,80 ±0,20	2,50	±0,25	0,50	330	xxx.xx.214	xxx.xx.210-h6
22,4	+0,50	22,0	10,80 ±0,20	2,50	±0,25	0,50	330	xxx.xx.224	xxx.xx.220-h6
23,4	+0,50	23,0	10,80 ±0,20	2,50	±0,25	0,50	330	xxx.xx.234	xxx.xx.230-h6
24,4	+0,50	24,0	11,75 ±0,25	3,00	±0,25	0,50	330	xxx.xx.244	xxx.xx.240-h6
25,4	+0,50	25,0	11,75 ±0,25	3,00	±0,25	0,50	330	xxx.xx.254	xxx.xx.250-h6
26,4	+0,50	26,0	12,75 ±0,25	3,00	±0,25	0,50	330	xxx.xx.264	xxx.xx.260-h6
28,4	+0,50	28,0	13,75 ±0,25	3,00	±0,25	0,50	330	xxx.xx.284	xxx.xx.280-h6
30,4	+0,50	30,0	13,75 ±0,25	3,00	±0,25	0,50	330	xxx.xx.304	xxx.xx.300-h6
32,4	+0,50	32,0	13,75 ±0,25	3,00	±0,25	0,50	330	xxx.xx.324	xxx.xx.320-h6
34,4	+0,50	34,0	13,75 ±0,25	3,00	±0,25	0,50	330	xxx.xx.344	xxx.xx.340-h6

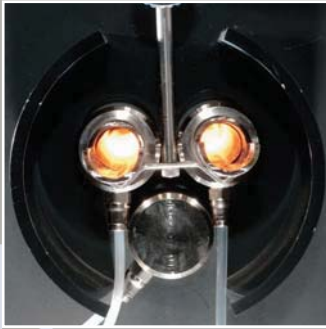

## parallel holes with reduced bolt circle

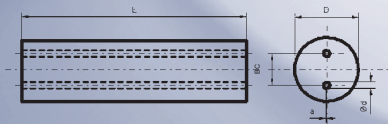

## grade:

**AF K10 UF** xxx.66.xxx  
**AF K20 CF** xxx.78.xxx  
**AF K34 EF** xxx.49.xxx

**AF K40 UF** xxx.70.xxx  
**AF K44 EF** xxx.62.xxx

article no.							213.xx.xxx		
dia.[mm] + Tol	dia.h6[mm]	BC	±Tol	hole Ø	±Tol	a	L +10[mm]	article no.	article no.
6,3	+0,30	6,0	±0,10	0,80	±0,10	0,15	330	xxx.xx.063	xxx.xx.060-h6
7,3	+0,30	7,0	±0,10	0,80	±0,10	0,15	330	xxx.xx.073	xxx.xx.070-h6
8,3	+0,30	8,0	±0,10	0,80	±0,10	0,15	330	xxx.xx.081	xxx.xx.081-h6
8,3	+0,30	8,0	±0,15	0,80	±0,10	0,15	330	xxx.xx.082	xxx.xx.082-h6
8,3	+0,30	8,0	±0,15	1,00	±0,10	0,15	330	xxx.xx.083	xxx.xx.080-h6
9,3	+0,30	9,0	±0,15	1,00	±0,10	0,20	330	xxx.xx.093	xxx.xx.090-h6
10,3	+0,30	10,0	±0,15	1,00	±0,10	0,20	330	xxx.xx.103	xxx.xx.100-h6
11,3	+0,40	11,0	±0,15	1,20	±0,15	0,28	330	xxx.xx.113	xxx.xx.110-h6
12,3	+0,40	12,0	±0,15	1,20	±0,15	0,30	330	xxx.xx.123	xxx.xx.120-h6
13,3	+0,40	13,0	±0,15	1,20	±0,15	0,34	330	xxx.xx.133	xxx.xx.130-h6
14,3	+0,40	14,0	±0,15	1,50	±0,15	0,37	330	xxx.xx.143	xxx.xx.140-h6
15,3	+0,40	15,0	±0,15	1,50	±0,15	0,40	330	xxx.xx.153	xxx.xx.150-h6
16,3	+0,40	16,0	±0,15	1,50	±0,15	0,40	330	xxx.xx.163	xxx.xx.160-h6
17,3	+0,50	17,0	±0,20	2,00	±0,20	0,47	330	xxx.xx.173	xxx.xx.170-h6
18,3	+0,50	18,0	±0,20	2,00	±0,20	0,50	330	xxx.xx.183	xxx.xx.180-h6
19,3	+0,50	19,0	±0,20	2,00	±0,20	0,50	330	xxx.xx.193	xxx.xx.190-h6
20,4	+0,50	20,0	±0,20	2,00	±0,20	0,50	330	xxx.xx.204	xxx.xx.200-h6
21,4	+0,50	21,0	±0,20	2,00	±0,20	0,50	330	xxx.xx.214	xxx.xx.210-h6
22,4	+0,50	22,0	±0,20	2,00	±0,20	0,50	330	xxx.xx.224	xxx.xx.220-h6
23,4	+0,50	23,0	±0,20	2,00	±0,20	0,50	330	xxx.xx.234	xxx.xx.230-h6
24,4	+0,50	24,0	±0,20	2,00	±0,20	0,50	330	xxx.xx.244	xxx.xx.240-h6
25,4	+0,50	25,0	±0,20	2,00	±0,20	0,50	330	xxx.xx.254	xxx.xx.250-h6



### 2 hole 30° helix with special bolt circle

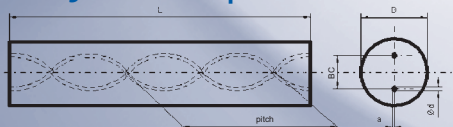

grade:

**AF K40 UF**    xxx.70.xxx  
**AF K44 EF**    xxx.62.xxx

article no.								283.xx.xxx	
dia.[mm] + Tol	BC ±Tol	hole Ø ±Tol	a	pitch ±Tol	±0,5°	L[mm] ±Tol	article no.		
<b>4,3</b> +0,30	<b>1,72</b> ±0,10	<b>0,80</b> ±0,10	<b>0,10</b>	<b>21,77</b> +0,45	-0,43	<b>330</b> +10	xxx.xx. <b>043</b>		
<b>5,3</b> +0,30	<b>1,92</b> ±0,10	<b>0,80</b> ±0,10	<b>0,13</b>	<b>27,21</b> +0,56	-0,54	<b>330</b> +10	xxx.xx. <b>053</b>		
<b>6,3</b> +0,30	<b>2,90</b> ±0,20	<b>1,00</b> ±0,10	<b>0,15</b>	<b>32,65</b> +0,67	-0,65	<b>330</b> +10	xxx.xx. <b>063</b>		
<b>8,3</b> +0,30	<b>3,85</b> ±0,20	<b>1,00</b> ±0,15	<b>0,15</b>	<b>43,53</b> +0,89	-0,86	<b>330</b> +10	xxx.xx. <b>083</b>		
<b>10,3</b> +0,30	<b>4,85</b> ±0,30	<b>1,40</b> ±0,15	<b>0,20</b>	<b>54,41</b> +1,11	-1,08	<b>330</b> +10	xxx.xx. <b>103</b>		
<b>12,3</b> +0,40	<b>5,85</b> ±0,40	<b>1,75</b> ±0,15	<b>0,30</b>	<b>65,30</b> +1,34	-1,30	<b>330</b> +10	xxx.xx. <b>123</b>		
<b>14,3</b> +0,40	<b>6,85</b> ±0,40	<b>1,75</b> ±0,15	<b>0,37</b>	<b>76,18</b> +1,56	-1,51	<b>330</b> +10	xxx.xx. <b>143</b>		
<b>16,3</b> +0,40	<b>7,85</b> ±0,40	<b>2,00</b> ±0,20	<b>0,40</b>	<b>87,06</b> +1,78	-1,73	<b>330</b> +10	xxx.xx. <b>163</b>		
<b>18,3</b> +0,50	<b>8,85</b> ±0,40	<b>2,00</b> ±0,20	<b>0,50</b>	<b>97,95</b> +2,00	-1,94	<b>330</b> +10	xxx.xx. <b>183</b>		
<b>20,3</b> +0,50	<b>9,80</b> ±0,40	<b>2,50</b> ±0,25	<b>0,50</b>	<b>108,83</b> +2,23	-2,16	<b>330</b> +10	xxx.xx. <b>203</b>		

## 2 hole 30° helix

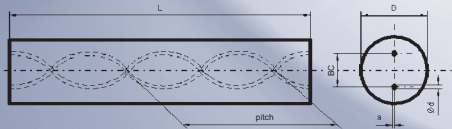

grade:

AF K10 UF  
AF K20 CF  
AF K34 EF

xxx.66.xxx  
xxx.78.xxx  
xxx.49.xxx

AF K40 UF  
AF K44 EF  
AF K45 EF

xxx.70.xxx  
xxx.62.xxx  
xxx.53.xxx

article no.

233.xx.xxx

dia.[mm] +Tol	dia.h6 [mm]	BC ±Tol	hole Ø ±Tol	pitch ±Tol ±0,5°	a	L +10 [mm]	article no.	article no.
3,3 +0,30	3,0	1,60 ±0,10	0,40 ±0,10	16,32 +0,33 -0,32	0,08	330	xxx.xx.033	xxx.xx.030-h6
3,8 +0,30	3,5	1,80 ±0,10	0,50 ±0,10	19,04 +0,39 -0,38	0,09	330	xxx.xx.038	xxx.xx.035-h6
4,3 +0,30	4,0	2,10 ±0,10	0,60 ±0,10	21,77 +0,45 -0,43	0,10	330	xxx.xx.043	xxx.xx.040-h6
4,8 +0,30	4,5	2,25 ±0,15	0,70 ±0,10	24,49 +0,50 -0,49	0,10	330	xxx.xx.048	xxx.xx.045-h6
5,3 +0,30	5,0	2,40 ±0,20	0,70 ±0,10	27,21 +0,56 -0,54	0,13	330	xxx.xx.053	xxx.xx.050-h6
5,8 +0,30	5,5	2,40 ±0,20	0,70 ±0,10	29,93 +0,61 -0,59	0,14	330	xxx.xx.058	xxx.xx.055-h6
6,3 +0,30	6,0	2,40 ±0,20	0,70 ±0,10	32,65 +0,67 -0,65	0,15	330	xxx.xx.063	xxx.xx.060-h6
6,8 +0,30	6,5	3,30 ±0,20	1,00 ±0,15	35,37 +0,72 -0,70	0,15	330	xxx.xx.068	xxx.xx.065-h6
7,3 +0,30	7,0	3,50 ±0,20	1,00 ±0,15	38,09 +0,78 -0,76	0,15	330	xxx.xx.073	xxx.xx.070-h6
7,8 +0,30	7,5	3,80 ±0,20	1,00 ±0,15	40,81 +0,84 -0,81	0,15	330	xxx.xx.078	xxx.xx.075-h6
8,3 +0,30	8,0	3,80 ±0,20	1,00 ±0,15	43,53 +0,89 -0,86	0,15	330	xxx.xx.083	xxx.xx.080-h6
8,8 +0,30	8,5	4,20 ±0,30	1,00 ±0,15	46,25 +0,95 -0,92	0,20	330	xxx.xx.088	xxx.xx.085-h6
9,3 +0,30	9,0	4,50 ±0,30	1,40 ±0,15	48,97 +1,00 -0,97	0,20	330	xxx.xx.093	xxx.xx.090-h6
9,8 +0,30	9,5	4,50 ±0,30	1,40 ±0,15	51,69 +1,06 -1,03	0,20	330	xxx.xx.098	xxx.xx.095-h6
10,3 +0,30	10,0	4,50 ±0,30	1,40 ±0,15	54,41 +1,11 -1,08	0,20	330	xxx.xx.103	xxx.xx.100-h6
10,8 +0,40	10,5	4,50 ±0,30	1,40 ±0,15	57,13 +1,17 -1,13	0,28	330	xxx.xx.108	xxx.xx.105-h6
11,3 +0,40	11,0	4,90 ±0,40	1,40 ±0,15	59,86 +1,22 -1,19	0,28	330	xxx.xx.113	xxx.xx.110-h6
11,8 +0,40	11,5	5,40 ±0,40	1,40 ±0,15	62,58 +1,28 -1,24	0,30	330	xxx.xx.118	xxx.xx.115-h6
12,3 +0,40	12,0	5,85 ±0,40	1,40 ±0,15	65,30 +1,34 -1,30	0,30	330	xxx.xx.123	xxx.xx.120-h6
12,8 +0,40	12,5	5,85 ±0,40	1,75 ±0,20	68,02 +1,39 -1,35	0,30	330	xxx.xx.128	xxx.xx.125-h6
13,3 +0,40	13,0	6,10 ±0,40	1,75 ±0,20	70,74 +1,45 -1,40	0,34	330	xxx.xx.133	xxx.xx.130-h6
13,8 +0,40	13,5	6,40 ±0,40	1,75 ±0,20	73,46 +1,50 -1,46	0,35	330	xxx.xx.138	xxx.xx.135-h6
14,3 +0,40	14,0	6,70 ±0,40	1,75 ±0,20	76,18 +1,56 -1,51	0,37	330	xxx.xx.143	xxx.xx.140-h6
14,8 +0,40	14,5	7,00 ±0,40	1,75 ±0,20	78,90 +1,61 -1,57	0,39	330	xxx.xx.148	xxx.xx.145-h6
15,3 +0,40	15,0	7,30 ±0,40	1,75 ±0,20	81,62 +1,67 -1,62	0,40	330	xxx.xx.153	xxx.xx.150-h6
15,8 +0,40	15,5	7,60 ±0,40	1,75 ±0,20	84,34 +1,73 -1,67	0,40	330	xxx.xx.158	xxx.xx.155-h6
16,3 +0,40	16,0	7,90 ±0,40	1,75 ±0,20	87,06 +1,78 -1,73	0,40	330	xxx.xx.163	xxx.xx.160-h6
16,8 +0,50	16,5	8,20 ±0,40	1,75 ±0,20	89,78 +1,84 -1,78	0,45	330	xxx.xx.168	xxx.xx.165-h6
17,3 +0,50	17,0	8,50 ±0,40	1,75 ±0,20	92,50 +1,89 -1,84	0,47	330	xxx.xx.173	xxx.xx.170-h6
17,8 +0,50	17,5	8,80 ±0,40	1,75 ±0,20	95,22 +1,95 -1,89	0,48	330	xxx.xx.178	xxx.xx.175-h6
18,3 +0,50	18,0	9,15 ±0,40	2,00 ±0,25	97,95 +2,00 -1,94	0,50	330	xxx.xx.183	xxx.xx.180-h6
18,8 +0,50	18,5	9,35 ±0,40	2,00 ±0,25	100,67 +2,06 -2,00	0,50	330	xxx.xx.188	xxx.xx.185-h6
19,3 +0,50	19,0	9,70 ±0,40	2,00 ±0,25	103,39 +2,12 -2,05	0,50	330	xxx.xx.193	xxx.xx.190-h6
19,8 +0,50	19,5	9,75 ±0,50	2,00 ±0,25	106,11 +2,17 -2,11	0,50	330	xxx.xx.198	xxx.xx.195-h6
20,3 +0,50	20,0	9,90 ±0,50	2,00 ±0,25	108,83 +2,23 -2,16	0,50	330	xxx.xx.203	xxx.xx.200-h6
21,3 +0,50	21,0	10,65 ±0,50	2,00 ±0,25	114,27 +2,34 -2,27	0,50	330	xxx.xx.213	xxx.xx.210-h6
22,3 +0,50	22,0	11,10 ±0,50	2,00 ±0,25	119,71 +2,45 -2,38	0,50	330	xxx.xx.223	xxx.xx.220-h6
23,3 +0,50	23,0	11,70 ±0,50	2,00 ±0,25	125,15 +2,56 -2,48	0,50	330	xxx.xx.233	xxx.xx.230-h6
24,3 +0,50	24,0	12,30 ±0,50	2,00 ±0,25	130,59 +2,67 -2,59	0,50	330	xxx.xx.243	xxx.xx.240-h6
25,3 +0,50	25,0	12,80 ±0,50	2,00 ±0,25	136,03 +2,78 -2,70	0,50	330	xxx.xx.253	xxx.xx.250-h6
26,3 +0,50	26,0	13,30 ±0,50	2,00 ±0,25	141,48 +2,90 -2,81	0,50	330	xxx.xx.263	xxx.xx.260-h6
28,3 +0,50	28,0	14,20 ±0,60	2,50 ±0,30	152,36 +3,12 -3,02	0,60	330	xxx.xx.283	xxx.xx.280-h6
30,3 +0,50	30,0	15,40 ±0,60	2,50 ±0,30	163,24 +3,34 -3,24	0,70	330	xxx.xx.303	xxx.xx.300-h6
32,3 +0,50	32,0	16,60 ±0,60	3,00 ±0,30	174,12 +3,56 -3,46	0,80	330	xxx.xx.323	xxx.xx.320-h6
34,3 +0,50	34,0	17,40 ±0,60	3,00 ±0,30	185,01 +3,79 -3,67	0,80	330	xxx.xx.343	xxx.xx.340-h6
35,3 +0,50	35,0	17,40 ±0,60	3,00 ±0,30	190,45 +3,90 -3,78	0,80	330	xxx.xx.353	xxx.xx.350-h6



2 hole 40° helix

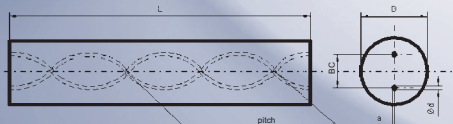

grade:

**AF K10 UF**  
**AF K20 CF**  
**AF K34 EF**

xxx.66.xxx  
xxx.78.xxx  
xxx.49.xxx

**AF K40 UF**  
**AF K44 EF**  
**AF K45 EF**

xxx.70.xxx  
xxx.62.xxx  
xxx.53.xxx

article no.								243.xx.xxx		
dia.[mm] +Tol	dia.h6[mm]	BC ±Tol	hole Ø ±Tol	pitch ±Tol	±0,5°	a	L +10[mm]	article no.	article no.	
6,3 +0,30	6,0	2,00 ±0,20	0,50 ±0,15	22,46 +0,40	-0,39	0,15	330	xxx.xx.063	xxx.xx.060-h6	
6,8 +0,30	6,5	2,10 ±0,20	0,50 ±0,15	24,34 +0,44	-0,43	0,15	330	xxx.xx.068	xxx.xx.065-h6	
7,3 +0,30	7,0	2,20 ±0,20	0,65 ±0,15	26,21 +0,47	-0,46	0,15	330	xxx.xx.073	xxx.xx.070-h6	
7,8 +0,30	7,5	2,30 ±0,20	0,65 ±0,15	28,08 +0,50	-0,49	0,15	330	xxx.xx.078	xxx.xx.075-h6	
8,3 +0,30	8,0	2,40 ±0,30	0,65 ±0,15	29,95 +0,54	-0,53	0,15	330	xxx.xx.083	xxx.xx.080-h6	
8,8 +0,30	8,5	2,60 ±0,30	0,65 ±0,15	31,82 +0,57	-0,56	0,20	330	xxx.xx.088	xxx.xx.085-h6	
9,3 +0,30	9,0	2,90 ±0,30	0,75 ±0,15	33,70 +0,60	-0,59	0,20	330	xxx.xx.093	xxx.xx.090-h6	
9,8 +0,30	9,5	3,20 ±0,30	0,75 ±0,15	35,57 +0,64	-0,62	0,20	330	xxx.xx.098	xxx.xx.095-h6	
10,3 +0,40	10,0	3,20 ±0,30	0,80 ±0,15	37,44 +0,67	-0,66	0,20	330	xxx.xx.103	xxx.xx.100-h6	
10,8 +0,40	10,5	3,20 ±0,30	0,80 ±0,15	39,31 +0,70	-0,69	0,28	330	xxx.xx.108	xxx.xx.105-h6	
11,3 +0,40	11,0	3,30 ±0,40	0,80 ±0,15	41,18 +0,74	-0,72	0,28	330	xxx.xx.113	xxx.xx.110-h6	
11,8 +0,40	11,5	3,60 ±0,40	0,85 ±0,15	43,06 +0,77	-0,76	0,30	330	xxx.xx.118	xxx.xx.115-h6	
12,3 +0,40	12,0	3,80 ±0,40	0,90 ±0,20	44,93 +0,80	-0,79	0,30	330	xxx.xx.123	xxx.xx.120-h6	
12,8 +0,40	12,5	3,95 ±0,40	0,90 ±0,20	46,80 +0,84	-0,82	0,33	330	xxx.xx.128	xxx.xx.125-h6	
13,3 +0,40	13,0	4,00 ±0,40	0,90 ±0,20	48,67 +0,87	-0,85	0,34	330	xxx.xx.133	xxx.xx.130-h6	
13,8 +0,40	13,5	4,10 ±0,40	1,00 ±0,20	50,54 +0,91	-0,89	0,35	330	xxx.xx.138	xxx.xx.135-h6	
14,3 +0,40	14,0	4,30 ±0,40	1,00 ±0,20	52,42 +0,94	-0,92	0,37	330	xxx.xx.143	xxx.xx.140-h6	
14,8 +0,40	14,5	4,50 ±0,40	1,10 ±0,20	54,29 +0,97	-0,95	0,39	330	xxx.xx.148	xxx.xx.145-h6	
15,3 +0,50	15,0	4,70 ±0,40	1,10 ±0,20	56,16 +1,01	-0,99	0,40	330	xxx.xx.153	xxx.xx.150-h6	
15,8 +0,50	15,5	4,90 ±0,40	1,10 ±0,20	58,03 +1,04	-1,02	0,40	330	xxx.xx.158	xxx.xx.155-h6	
16,3 +0,50	16,0	5,10 ±0,40	1,20 ±0,20	59,90 +1,07	-1,05	0,40	330	xxx.xx.163	xxx.xx.160-h6	
16,8 +0,50	16,5	5,35 ±0,40	1,20 ±0,25	61,78 +1,11	-1,08	0,45	330	xxx.xx.168	xxx.xx.165-h6	
17,3 +0,50	17,0	5,50 ±0,40	1,20 ±0,25	63,65 +1,14	-1,12	0,47	330	xxx.xx.173	xxx.xx.170-h6	
17,8 +0,50	17,5	5,70 ±0,40	1,30 ±0,25	65,52 +1,17	-1,15	0,48	330	xxx.xx.178	xxx.xx.175-h6	
18,3 +0,50	18,0	5,90 ±0,40	1,40 ±0,25	67,39 +1,21	-1,18	0,50	330	xxx.xx.183	xxx.xx.180-h6	
18,8 +0,50	18,5	6,10 ±0,40	1,40 ±0,25	69,26 +1,24	-1,21	0,50	330	xxx.xx.188	xxx.xx.185-h6	
19,3 +0,50	19,0	6,40 ±0,50	1,40 ±0,25	71,14 +1,27	-1,25	0,50	330	xxx.xx.193	xxx.xx.190-h6	
20,3 +0,50	20,0	6,60 ±0,50	1,50 ±0,25	74,88 +1,34	-1,31	0,50	330	xxx.xx.203	xxx.xx.200-h6	
21,3 +0,50	21,0	6,90 ±0,50	1,50 ±0,25	78,62 +1,41	-1,38	0,50	330	xxx.xx.213	xxx.xx.210-h6	
22,3 +0,50	22,0	7,20 ±0,50	1,70 ±0,25	82,37 +1,48	-1,44	0,50	330	xxx.xx.223	xxx.xx.220-h6	
24,3 +0,50	24,0	7,50 ±0,50	1,75 ±0,25	89,86 +1,61	-1,58	0,50	330	xxx.xx.243	xxx.xx.240-h6	
25,3 +0,50	25,0	7,60 ±0,50	1,75 ±0,25	93,60 +1,68	-1,64	0,50	330	xxx.xx.253	xxx.xx.250-h6	
26,3 +0,50	26,0	7,70 ±0,50	1,75 ±0,25	97,34 +1,74	-1,71	0,50	330	xxx.xx.263	xxx.xx.260-h6	
28,3 +0,50	28,0	8,40 ±0,60	2,00 ±0,30	104,83 +1,88	-1,84	0,50	330	xxx.xx.283	xxx.xx.280-h6	
30,3 +0,50	30,0	9,40 ±0,60	2,00 ±0,30	112,32 +2,01	-1,97	0,50	330	xxx.xx.303	xxx.xx.300-h6	
32,3 +0,50	32,0	10,40 ±0,60	2,00 ±0,30	119,81 +2,15	-2,10	0,50	330	xxx.xx.323	xxx.xx.320-h6	

## 3 hole 30° helix

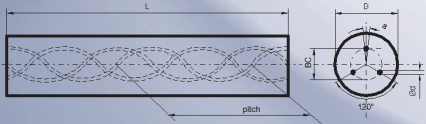

## grade:

**AF K20 CF**  
**AF K34 EF**

**xxx.78.xxx**  
**xxx.49.xxx**

**AF K40 UF**  
**AF K44 EF**

**xxx.70.xxx**  
**xxx.62.xxx**

article no.								333.xx.xxx		
dia.[mm] +Tol	dia.h6[mm]	BC ±Tol	hole Ø ±Tol	pitch ±Tol ±0,5°	α	L +10[mm]	article no.	article no.		
4,8 +0,30	4,5	2,20 ±0,10	0,40 ±0,10	24,49 +0,50 -0,49	±4°	330	xxx.xx.048	xxx.xx.045-h6		
5,3 +0,30	5,0	2,45 ±0,15	0,40 ±0,10	27,21 +0,56 -0,54	±4°	330	xxx.xx.053	xxx.xx.050-h6		
5,8 +0,30	5,5	2,75 ±0,15	0,50 ±0,10	29,93 +0,61 -0,59	±4°	330	xxx.xx.058	xxx.xx.055-h6		
6,3 +0,30	6,0	2,75 ±0,15	0,50 ±0,10	32,65 +0,67 -0,65	±4°	330	xxx.xx.063	xxx.xx.060-h6		
6,8 +0,30	6,5	2,75 ±0,15	0,50 ±0,10	35,37 +0,72 -0,70	±4°	330	xxx.xx.068	xxx.xx.065-h6		
7,3 +0,30	7,0	3,85 ±0,15	0,65 ±0,10	38,09 +0,78 -0,76	±4°	330	xxx.xx.073	xxx.xx.070-h6		
7,8 +0,30	7,5	3,85 ±0,15	0,70 ±0,10	40,81 +0,84 -0,81	±4°	330	xxx.xx.078	xxx.xx.075-h6		
8,3 +0,30	8,0	3,85 ±0,15	0,70 ±0,10	43,53 +0,89 -0,86	±4°	330	xxx.xx.083	xxx.xx.080-h6		
8,8 +0,30	8,5	3,85 ±0,15	0,70 ±0,10	46,25 +0,95 -0,92	±4°	330	xxx.xx.088	xxx.xx.085-h6		
9,3 +0,30	9,0	4,95 ±0,15	0,85 ±0,15	48,97 +1,00 -0,97	±4°	330	xxx.xx.093	xxx.xx.090-h6		
9,8 +0,30	9,5	4,95 ±0,15	0,85 ±0,15	51,69 +1,06 -1,03	±4°	330	xxx.xx.098	xxx.xx.095-h6		
10,3 +0,30	10,0	4,95 ±0,15	0,85 ±0,15	54,41 +1,11 -1,08	±4°	330	xxx.xx.103	xxx.xx.100-h6		
10,8 +0,40	10,5	4,95 ±0,15	0,85 ±0,15	57,13 +1,17 -1,13	±4°	330	xxx.xx.108	xxx.xx.105-h6		
11,3 +0,40	11,0	5,45 ±0,25	1,10 ±0,15	59,86 +1,22 -1,19	±4°	330	xxx.xx.113	xxx.xx.110-h6		
11,8 +0,40	11,5	5,85 ±0,25	1,10 ±0,15	62,58 +1,28 -1,24	±4°	330	xxx.xx.118	xxx.xx.115-h6		
12,3 +0,40	12,0	6,05 ±0,25	1,10 ±0,15	65,30 +1,34 -1,30	±4°	330	xxx.xx.123	xxx.xx.120-h6		
12,8 +0,40	12,5	6,05 ±0,25	1,10 ±0,15	68,02 +1,39 -1,35	±4°	330	xxx.xx.128	xxx.xx.125-h6		
13,3 +0,40	13,0	6,55 ±0,25	1,20 ±0,15	70,74 +1,45 -1,40	±4°	330	xxx.xx.133	xxx.xx.130-h6		
13,8 +0,40	13,5	6,75 ±0,25	1,20 ±0,15	73,46 +1,50 -1,46	±4°	330	xxx.xx.138	xxx.xx.135-h6		
14,3 +0,40	14,0	7,05 ±0,25	1,40 ±0,15	76,18 +1,56 -1,51	±4°	330	xxx.xx.143	xxx.xx.140-h6		
14,8 +0,40	14,5	7,35 ±0,25	1,40 ±0,15	78,90 +1,61 -1,57	±4°	330	xxx.xx.148	xxx.xx.145-h6		
15,3 +0,40	15,0	7,55 ±0,25	1,40 ±0,15	81,62 +1,67 -1,62	±4°	330	xxx.xx.153	xxx.xx.150-h6		
16,3 +0,40	16,0	8,05 ±0,25	1,60 ±0,20	87,06 +1,78 -1,73	±4°	330	xxx.xx.163	xxx.xx.160-h6		
17,3 +0,50	17,0	8,35 ±0,25	1,60 ±0,20	92,50 +1,89 -1,84	±4°	330	xxx.xx.173	xxx.xx.170-h6		
18,3 +0,50	18,0	9,25 ±0,25	1,70 ±0,20	97,95 +2,00 -1,94	±4°	330	xxx.xx.183	xxx.xx.180-h6		
19,3 +0,50	19,0	9,95 ±0,25	1,70 ±0,20	103,39 +2,12 -2,05	±4°	330	xxx.xx.193	xxx.xx.190-h6		
20,3 +0,50	20,0	9,95 ±0,25	1,90 ±0,25	108,83 +2,23 -2,16	±4°	330	xxx.xx.203	xxx.xx.200-h6		
21,3 +0,50	21,0	10,75 ±0,35	2,00 ±0,25	114,27 +2,34 -2,27	±4°	330	xxx.xx.213	xxx.xx.210-h6		
22,3 +0,50	22,0	11,15 ±0,35	2,00 ±0,25	119,71 +2,45 -2,38	±4°	330	xxx.xx.223	xxx.xx.220-h6		
23,3 +0,50	23,0	11,45 ±0,35	2,00 ±0,25	125,15 +2,56 -2,48	±4°	330	xxx.xx.233	xxx.xx.230-h6		
24,3 +0,50	24,0	11,75 ±0,35	2,00 ±0,25	130,59 +2,67 -2,59	±4°	330	xxx.xx.243	xxx.xx.240-h6		
25,3 +0,50	25,0	12,15 ±0,35	2,00 ±0,25	136,03 +2,78 -2,70	±4°	330	xxx.xx.253	xxx.xx.250-h6		
26,3 +0,50	26,0	12,75 ±0,35	2,00 ±0,25	141,48 +2,90 -2,81	±4°	330	xxx.xx.263	xxx.xx.260-h6		
28,3 +0,50	28,0	13,65 ±0,45	2,50 ±0,30	152,36 +3,12 -3,02	±4°	330	xxx.xx.283	xxx.xx.280-h6		
30,3 +0,50	30,0	14,50 ±0,60	2,50 ±0,30	163,24 +3,34 -3,24	±4°	330	xxx.xx.303	xxx.xx.300-h6		
32,3 +0,50	32,0	15,50 ±0,60	3,00 ±0,30	174,12 +3,56 -3,46	±4°	330	xxx.xx.323	xxx.xx.320-h6		

## 3 hole 40° helix

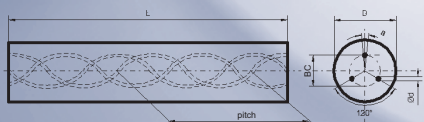

## grade:

AF K20 CF  
AF K34 EFxxx.78.xxx  
xxx.49.xxxAF K40 UF  
AF K44 EFxxx.70.xxx  
xxx.62.xxx

## article no.

article no.								343.xx.xxx		
dia.[mm] + Tol	dia.h6[mm]	BC ±Tol	hole Ø ±Tol	pitch ±Tol	±0,5°	α	L +10[mm]	article no.	article no.	
6,3 +0,30	6,0	2,05 ±0,15	0,50 ±0,15	22,46 +0,40	-0,39	±4°	330	xxx.xx.063	xxx.xx.060-h6	
6,8 +0,30	6,5	2,15 ±0,15	0,50 ±0,15	24,34 +0,44	-0,43	±4°	330	xxx.xx.068	xxx.xx.065-h6	
7,3 +0,30	7,0	2,25 ±0,15	0,65 ±0,15	26,21 +0,47	-0,46	±4°	330	xxx.xx.073	xxx.xx.070-h6	
7,8 +0,30	7,5	2,35 ±0,15	0,65 ±0,15	28,08 +0,50	-0,49	±4°	330	xxx.xx.078	xxx.xx.075-h6	
8,3 +0,30	8,0	2,45 ±0,15	0,65 ±0,15	29,95 +0,54	-0,53	±4°	330	xxx.xx.083	xxx.xx.080-h6	
8,8 +0,30	8,5	2,75 ±0,15	0,65 ±0,15	31,82 +0,57	-0,56	±4°	330	xxx.xx.088	xxx.xx.085-h6	
9,3 +0,30	9,0	3,05 ±0,15	0,75 ±0,15	33,70 +0,60	-0,59	±4°	330	xxx.xx.093	xxx.xx.090-h6	
9,8 +0,30	9,5	3,35 ±0,15	0,75 ±0,15	35,57 +0,64	-0,62	±4°	330	xxx.xx.098	xxx.xx.095-h6	
10,3 +0,40	10,0	3,35 ±0,15	0,80 ±0,15	37,44 +0,67	-0,66	±4°	330	xxx.xx.103	xxx.xx.100-h6	
10,8 +0,40	10,5	3,35 ±0,15	0,80 ±0,15	39,31 +0,70	-0,69	±4°	330	xxx.xx.108	xxx.xx.105-h6	
11,3 +0,40	11,0	3,45 ±0,25	0,80 ±0,15	41,18 +0,74	-0,72	±4°	330	xxx.xx.113	xxx.xx.110-h6	
11,8 +0,40	11,5	3,75 ±0,25	0,85 ±0,15	43,06 +0,77	-0,76	±4°	330	xxx.xx.118	xxx.xx.115-h6	
12,3 +0,40	12,0	3,95 ±0,25	0,90 ±0,20	44,93 +0,80	-0,79	±4°	330	xxx.xx.123	xxx.xx.120-h6	
12,8 +0,40	12,5	4,10 ±0,25	0,90 ±0,20	46,80 +0,84	-0,82	±4°	330	xxx.xx.128	xxx.xx.125-h6	
13,3 +0,40	13,0	4,15 ±0,25	0,90 ±0,20	48,67 +0,87	-0,85	±4°	330	xxx.xx.133	xxx.xx.130-h6	
13,8 +0,40	13,5	4,25 ±0,25	1,00 ±0,20	50,54 +0,91	-0,89	±4°	330	xxx.xx.138	xxx.xx.135-h6	
14,3 +0,40	14,0	4,45 ±0,25	1,00 ±0,20	52,42 +0,94	-0,92	±4°	330	xxx.xx.143	xxx.xx.140-h6	
14,8 +0,40	14,5	4,65 ±0,25	1,10 ±0,20	54,29 +0,97	-0,95	±4°	330	xxx.xx.148	xxx.xx.145-h6	
15,3 +0,50	15,0	4,85 ±0,25	1,10 ±0,20	56,16 +1,01	-0,99	±4°	330	xxx.xx.153	xxx.xx.150-h6	
16,3 +0,50	16,0	5,25 ±0,25	1,20 ±0,20	59,90 +1,07	-1,05	±4°	330	xxx.xx.163	xxx.xx.160-h6	
17,3 +0,50	17,0	5,65 ±0,25	1,20 ±0,20	63,65 +1,14	-1,12	±4°	330	xxx.xx.173	xxx.xx.170-h6	
18,3 +0,50	18,0	6,05 ±0,25	1,40 ±0,25	67,39 +1,21	-1,18	±4°	330	xxx.xx.183	xxx.xx.180-h6	
19,3 +0,50	19,0	6,35 ±0,35	1,40 ±0,25	71,14 +1,27	-1,25	±4°	330	xxx.xx.193	xxx.xx.190-h6	
20,3 +0,50	20,0	6,75 ±0,35	1,50 ±0,25	74,88 +1,34	-1,31	±4°	330	xxx.xx.203	xxx.xx.200-h6	
21,3 +0,50	21,0	7,05 ±0,35	1,50 ±0,25	78,62 +1,41	-1,38	±4°	330	xxx.xx.213	xxx.xx.210-h6	
22,3 +0,50	22,0	7,35 ±0,35	1,70 ±0,25	82,37 +1,48	-1,44	±4°	330	xxx.xx.223	xxx.xx.220-h6	
24,3 +0,50	24,0	7,55 ±0,45	1,75 ±0,25	89,86 +1,61	-1,58	±4°	330	xxx.xx.243	xxx.xx.240-h6	
25,3 +0,50	25,0	7,65 ±0,45	1,75 ±0,25	93,60 +1,68	-1,64	±4°	330	xxx.xx.253	xxx.xx.250-h6	
26,3 +0,50	26,0	7,75 ±0,45	1,75 ±0,25	97,34 +1,74	-1,71	±4°	330	xxx.xx.263	xxx.xx.260-h6	
28,3 +0,50	28,0	8,55 ±0,45	2,00 ±0,30	104,83 +1,88	-1,84	±4°	330	xxx.xx.283	xxx.xx.280-h6	
30,3 +0,50	30,0	9,45 ±0,55	2,00 ±0,30	112,32 +2,01	-1,97	±4°	330	xxx.xx.303	xxx.xx.300-h6	
32,3 +0,50	32,0	10,45 ±0,55	2,00 ±0,30	119,81 +2,15	-2,10	±4°	330	xxx.xx.323	xxx.xx.320-h6	

# MILLING BLANKS FOR INDIVIDUAL TOOLS

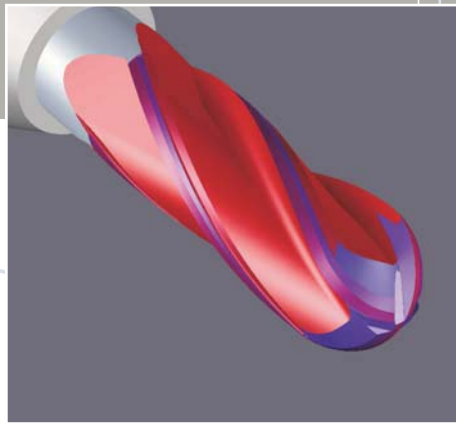

We take account of your special wishes by machining our carbide in the green state.

**We provide your tools in this early stage with an individual touch:**

- We machine the ends of your tools.
- You benefit from individual coolant inlet which matches the application for your tools.
- An especially elegant solution: with the inclusion of chipping space, only the grinding of your tool cutter is still necessary
- We will also perform the same preparation work for drill bits: with additional polishing of the chipping space, only the grinding of the cutter is still necessary for you.





# G B L A N K S



### Your advantage – our preparatory work

The machining of your tools in the green state means that your work is made significantly easier. You benefit from a reduction of almost 90% in the grinding effort.

### Our advantage – optimum material recovery

Material removed in the green state is handled as pure grade material. This means optimum utilization of material as we can use it further in our process.



milling cutter blanks				grade:	
				<b>AF K40 UF</b> 009.70.xxx <b>AF K44 EF</b> 009.62.xxx	
dia.[mm]	+Tol	L [mm]	+Tol	F x 45°	article no.
6,2	+0,20	58,0	+0,8	0,5	009.xx.062
6,2	+0,20	76,5	+0,9	0,5	009.xx.064
8,2	+0,30	64,2	+0,8	1,0	009.xx.082
8,2	+0,30	101,2	+1,0	1,0	009.xx.084
10,2	+0,30	67,2	+0,8	1,0	009.xx.102
10,2	+0,30	73,2	+0,9	1,0	009.xx.103
10,2	+0,30	101,2	+1,0	1,0	009.xx.104
12,2	+0,30	74,2	+0,9	1,0	009.xx.122
12,2	+0,30	84,2	+0,9	1,0	009.xx.123
12,2	+0,30	101,1	+1,0	1,0	009.xx.124
14,2	+0,30	84,2	+0,9	1,0	009.xx.142
14,2	+0,30	101,2	+1,0	1,0	009.xx.144
16,2	+0,40	83,2	+0,9	1,5	009.xx.162
16,2	+0,40	93,2	+1,0	1,5	009.xx.163
16,2	+0,40	101,2	+1,0	1,5	009.xx.164
18,2	+0,40	93,0	+1,0	1,5	009.xx.182
18,2	+0,40	102,0	+1,0	1,5	009.xx.183
18,2	+0,40	151,3	+1,6	1,5	009.xx.184
20,2	+0,50	93,2	+1,0	1,5	009.xx.202
20,2	+0,50	105,0	+1,1	1,5	009.xx.203
20,2	+0,50	151,2	+1,6	1,5	009.xx.204
25,2	+0,50	122,0	+1,2	1,5	009.xx.252
25,2	+0,50	152,0	+1,6	1,5	009.xx.254

				grade:	
				<b>AF K40 UF</b> 009.70.xxx - xxx h6 <b>AF K44 EF</b> 009.62.xxx - xxx h6	
dia.[mm]	Tol	L [mm]	+Tol	F x 45°	article no.
6,0	h6	58,0	+0,8	0,5	009.xx.060 - 058 h6
6,0	h6	76,5	+0,9	0,5	009.xx.060 - 076 h6
8,0	h6	64,2	+0,8	1,0	009.xx.080 - 064 h6
8,0	h6	101,2	+1,0	1,0	009.xx.080 - 101 h6
10,0	h6	67,2	+0,8	1,0	009.xx.100 - 067 h6
10,0	h6	73,2	+0,9	1,0	009.xx.100 - 073 h6
10,0	h6	101,2	+1,0	1,0	009.xx.100 - 101 h6
12,0	h6	74,2	+0,9	1,0	009.xx.120 - 074 h6
12,0	h6	84,2	+0,9	1,0	009.xx.120 - 084 h6
12,0	h6	101,1	+1,0	1,0	009.xx.120 - 101 h6
14,0	h6	84,2	+0,9	1,0	009.xx.140 - 084 h6
14,0	h6	101,2	+1,0	1,0	009.xx.140 - 101 h6
16,0	h6	83,2	+0,9	1,5	009.xx.160 - 083 h6
16,0	h6	93,2	+1,0	1,5	009.xx.160 - 093 h6
16,0	h6	101,2	+1,0	1,5	009.xx.160 - 101 h6
18,0	h6	93,0	+1,0	1,5	009.xx.180 - 093 h6
18,0	h6	102,0	+1,0	1,5	009.xx.180 - 102 h6
18,0	h6	151,3	+1,6	1,5	009.xx.180 - 151 h6
20,0	h6	93,2	+1,0	1,5	009.xx.200 - 093 h6
20,0	h6	105,0	+1,1	1,5	009.xx.200 - 105 h6
20,0	h6	151,2	+1,6	1,5	009.xx.200 - 151 h6
25,0	h6	122,0	+1,2	1,5	009.xx.250 - 122 h6
25,0	h6	152,0	+1,6	1,5	009.xx.250 - 152 h6



grade: **AF K40 UF**

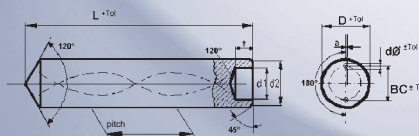

**drill blanks – short and long version**

2 coolant holes - 30° helix  
with coolant connection and 120° cone

dia.[mm] <sup>+Tol</sup>	dia.[mm] <sup>Tol</sup>	BC <sup>±Tol</sup>	dØ <sup>±Tol</sup>	pitch	a	L [mm] <sup>+Tol</sup>	d1 <sup>±Tol</sup>	t <sup>±Tol</sup>	d2 <sup>+Tol</sup>	article no.	article no.
6,3 <sup>+0,3</sup>	6,0 <sup>h6</sup>	2,40 <sup>±0,20</sup>	0,70 <sup>±0,10</sup>	32,65	0,15	68,0 <sup>+1,5</sup>	2,40 <sup>±0,20</sup>	1,8 <sup>±0,20</sup>	4,8 <sup>+0,2</sup>	238.70.063	238.70.060-h6
8,3 <sup>+0,3</sup>	8,0 <sup>h6</sup>	3,80 <sup>±0,20</sup>	1,00 <sup>±0,15</sup>	43,53	0,15	82,0 <sup>+1,5</sup>	3,80 <sup>±0,20</sup>	2,2 <sup>±0,20</sup>	6,8 <sup>+0,2</sup>	238.70.083	238.70.080-h6
10,3 <sup>+0,3</sup>	10,0 <sup>h6</sup>	4,50 <sup>±0,30</sup>	1,40 <sup>±0,15</sup>	54,41	0,20	92,0 <sup>+1,5</sup>	4,50 <sup>±0,30</sup>	2,8 <sup>±0,20</sup>	8,8 <sup>+0,2</sup>	238.70.103	238.70.100-h6
12,3 <sup>+0,4</sup>	12,0 <sup>h6</sup>	5,85 <sup>±0,40</sup>	1,40 <sup>±0,15</sup>	65,30	0,30	105,0 <sup>+1,5</sup>	5,85 <sup>±0,40</sup>	3,2 <sup>±0,30</sup>	10,8 <sup>+0,3</sup>	238.70.123	238.70.120-h6
14,3 <sup>+0,4</sup>	14,0 <sup>h6</sup>	6,70 <sup>±0,40</sup>	1,75 <sup>±0,20</sup>	76,18	0,37	110,0 <sup>+1,5</sup>	6,70 <sup>±0,40</sup>	3,6 <sup>±0,30</sup>	12,3 <sup>+0,2</sup>	238.70.143	238.70.140-h6
16,3 <sup>+0,4</sup>	16,0 <sup>h6</sup>	7,90 <sup>±0,40</sup>	1,75 <sup>±0,20</sup>	87,06	0,40	118,0 <sup>+1,5</sup>	7,90 <sup>±0,40</sup>	3,6 <sup>±0,30</sup>	14,3 <sup>+0,2</sup>	238.70.163	238.70.160-h6
18,3 <sup>+0,5</sup>	18,0 <sup>h6</sup>	9,15 <sup>±0,40</sup>	2,00 <sup>±0,25</sup>	97,95	0,50	126,0 <sup>+2,0</sup>	9,15 <sup>±0,40</sup>	3,8 <sup>±0,40</sup>	16,3 <sup>+0,2</sup>	238.70.183	238.70.180-h6
20,3 <sup>+0,5</sup>	20,0 <sup>h6</sup>	9,90 <sup>±0,50</sup>	2,00 <sup>±0,25</sup>	108,83	0,50	135,0 <sup>+2,0</sup>	9,90 <sup>±0,50</sup>	4,0 <sup>±0,40</sup>	18,3 <sup>+0,3</sup>	238.70.203	238.70.200-h6

dia.[mm] <sup>+Tol</sup>	dia.[mm] <sup>Tol</sup>	BC <sup>±Tol</sup>	dØ <sup>±Tol</sup>	pitch	a	L [mm] <sup>+Tol</sup>	d1 <sup>±Tol</sup>	t <sup>±Tol</sup>	d2 <sup>+Tol</sup>	article no.	article no.
6,3 <sup>+0,3</sup>	6,0 <sup>h6</sup>	2,40 <sup>±0,20</sup>	0,70 <sup>±0,10</sup>	32,65	0,15	84,0 <sup>+1,5</sup>	2,40 <sup>±0,20</sup>	1,8 <sup>±0,20</sup>	4,8 <sup>+0,2</sup>	239.70.063	239.70.060-h6
8,3 <sup>+0,3</sup>	8,0 <sup>h6</sup>	3,80 <sup>±0,20</sup>	1,00 <sup>±0,15</sup>	43,53	0,15	92,0 <sup>+1,5</sup>	3,80 <sup>±0,20</sup>	2,2 <sup>±0,20</sup>	6,8 <sup>+0,2</sup>	239.70.083	239.70.080-h6
10,3 <sup>+0,3</sup>	10,0 <sup>h6</sup>	4,50 <sup>±0,30</sup>	1,40 <sup>±0,15</sup>	54,41	0,20	105,0 <sup>+1,5</sup>	4,50 <sup>±0,30</sup>	2,8 <sup>±0,20</sup>	8,8 <sup>+0,2</sup>	239.70.103	239.70.100-h6
12,3 <sup>+0,4</sup>	12,0 <sup>h6</sup>	5,85 <sup>±0,40</sup>	1,40 <sup>±0,15</sup>	65,30	0,30	120,0 <sup>+1,5</sup>	5,85 <sup>±0,40</sup>	3,2 <sup>±0,30</sup>	10,8 <sup>+0,3</sup>	239.70.123	239.70.120-h6
14,3 <sup>+0,4</sup>	14,0 <sup>h6</sup>	6,70 <sup>±0,40</sup>	1,75 <sup>±0,20</sup>	76,18	0,37	126,0 <sup>+1,5</sup>	6,70 <sup>±0,40</sup>	3,6 <sup>±0,30</sup>	12,3 <sup>+0,2</sup>	239.70.143	239.70.140-h6
16,3 <sup>+0,4</sup>	16,0 <sup>h6</sup>	7,90 <sup>±0,40</sup>	1,75 <sup>±0,20</sup>	87,06	0,40	136,0 <sup>+1,5</sup>	7,90 <sup>±0,40</sup>	3,6 <sup>±0,30</sup>	14,3 <sup>+0,2</sup>	239.70.163	239.70.160-h6
18,3 <sup>+0,5</sup>	18,0 <sup>h6</sup>	9,15 <sup>±0,40</sup>	2,00 <sup>±0,25</sup>	97,95	0,50	146,0 <sup>+2,0</sup>	9,15 <sup>±0,40</sup>	3,8 <sup>±0,40</sup>	16,3 <sup>+0,2</sup>	239.70.183	239.70.180-h6
20,3 <sup>+0,5</sup>	20,0 <sup>h6</sup>	9,90 <sup>±0,50</sup>	2,00 <sup>±0,25</sup>	108,83	0,50	156,0 <sup>+2,0</sup>	9,90 <sup>±0,50</sup>	4,0 <sup>±0,40</sup>	18,3 <sup>+0,3</sup>	239.70.203	239.70.200-h6

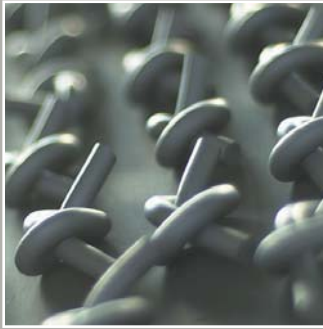

### milling cutter blanks

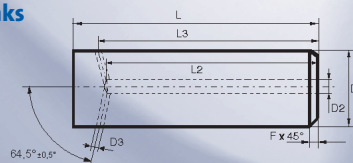

with center coolant duct and  
2, 3, 4, 5 lateral exits

### dimensions

dia.[mm]	+Tol	L [mm]	+Tol	Ø D2	±Tol	L2	Ø D3	±Tol	L3	±Tol	F x 45°
6,2	+0,20	58,0	+0,8	1,75	±0,25	54,6	1,0	±0,2	55,0	±0,30	0,5
6,2	+0,20	76,5	+0,9	1,75	±0,25	72,6	1,0	±0,2	73,0	±0,30	0,5
8,2	+0,30	64,2	+0,8	1,75	±0,25	59,1	1,2	±0,2	60,0	±0,30	1,0
8,2	+0,30	101,2	+1,0	1,75	±0,25	96,1	1,2	±0,2	97,0	±0,30	1,0
10,2	+0,30	67,2	+0,8	2,00	±0,25	60,6	1,2	±0,2	62,0	±0,30	1,0
10,2	+0,30	73,2	+0,9	2,00	±0,25	66,6	1,2	±0,2	68,0	±0,30	1,0
10,2	+0,30	101,2	+1,0	2,00	±0,25	94,6	1,2	±0,2	96,0	±0,30	1,0
12,2	+0,30	74,2	+0,9	2,00	±0,25	66,1	1,5	±0,2	68,0	±0,30	1,0
12,2	+0,30	84,2	+0,9	2,00	±0,25	76,1	1,5	±0,2	78,0	±0,30	1,0
12,2	+0,30	101,1	+1,0	2,00	±0,25	93,1	1,5	±0,2	95,0	±0,30	1,0
14,2	+0,30	84,2	+0,9	2,00	±0,25	74,7	1,5	±0,2	77,0	±0,30	1,0
14,2	+0,30	101,2	+1,0	2,00	±0,25	91,7	1,5	±0,2	94,0	±0,30	1,0
16,2	+0,40	83,2	+0,9	4,00	±0,25	72,2	1,5	±0,2	75,0	±0,30	1,5
16,2	+0,40	93,2	+1,0	4,00	±0,25	82,2	1,5	±0,2	85,0	±0,30	1,5
16,2	+0,40	101,2	+1,0	4,00	±0,25	90,2	1,5	±0,2	93,0	±0,30	1,5
18,2	+0,40	93,0	+1,0	4,00	±0,25	80,7	2,0	±0,2	84,0	±0,30	1,5
18,2	+0,40	102,0	+1,0	4,00	±0,25	89,7	2,0	±0,2	93,0	±0,30	1,5
18,2	+0,40	151,3	+1,6	4,00	±0,25	138,7	2,0	±0,2	142,0	±0,30	1,5
20,2	+0,50	93,2	+1,0	4,00	±0,25	79,2	2,0	±0,2	83,0	±0,30	1,5
20,2	+0,50	105,0	+1,1	4,00	±0,25	91,2	2,0	±0,2	95,0	±0,30	1,5
20,2	+0,50	151,2	+1,6	4,00	±0,25	137,2	2,0	±0,2	141,0	±0,30	1,5
25,2	+0,50	122,0	+1,2	4,00	±0,25	104,5	2,0	±0,2	109,5	±0,30	1,5
25,2	+0,50	152,0	+1,6	4,00	±0,25	134,5	2,0	±0,2	139,5	±0,30	1,5



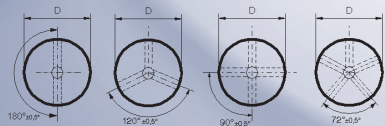

**AF K40 UF**    xxx.70.xxx  
**AF K44 EF**    xxx.62.xxx

article no.		922.xx.xxx	923.xx.xxx	924.xx.xxx	925.xx.xxx
dia.[mm]	L [mm]	article no.	article no.	article no.	article no.
6,2	58,0	922.xx.062	923.xx.062	924.xx.062	925.xx.062
6,2	76,5	922.xx.064	923.xx.064	924.xx.064	925.xx.064
8,2	64,2	922.xx.082	923.xx.082	924.xx.082	925.xx.082
8,2	101,2	922.xx.084	923.xx.084	924.xx.084	925.xx.084
10,2	67,2	922.xx.102	923.xx.102	924.xx.102	925.xx.102
10,2	73,2	922.xx.103	923.xx.103	924.xx.103	925.xx.103
10,2	101,2	922.xx.104	923.xx.104	924.xx.104	925.xx.104
12,2	74,2	922.xx.122	923.xx.122	924.xx.122	925.xx.122
12,2	84,2	922.xx.123	923.xx.123	924.xx.123	925.xx.123
12,2	101,1	922.xx.124	923.xx.124	924.xx.124	925.xx.124
14,2	84,2	922.xx.142	923.xx.142	924.xx.142	925.xx.142
14,2	101,2	922.xx.144	923.xx.144	924.xx.144	925.xx.144
16,2	83,2	922.xx.162	923.xx.162	924.xx.162	925.xx.162
16,2	93,2	922.xx.163	923.xx.163	924.xx.163	925.xx.163
16,2	101,2	922.xx.164	923.xx.164	924.xx.164	925.xx.164
18,2	93,0	922.xx.182	923.xx.182	924.xx.182	925.xx.182
18,2	102,0	922.xx.183	923.xx.183	924.xx.183	925.xx.183
18,2	151,3	922.xx.184	923.xx.184	924.xx.184	925.xx.184
20,2	93,2	922.xx.202	923.xx.202	924.xx.202	925.xx.202
20,2	105,0	922.xx.203	923.xx.203	924.xx.203	925.xx.203
20,2	151,2	922.xx.204	923.xx.204	924.xx.204	925.xx.204
25,2	122,0	922.xx.252	923.xx.252	924.xx.252	925.xx.252
25,2	152,0	922.xx.254	923.xx.254	924.xx.254	925.xx.254

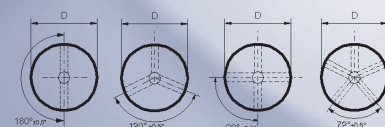

**AF K40 UF**    xxx.70.xxx-xxx  
**AF K44 EF**    xxx.62.xxx-xxx

article no.		922.xx.xxx-xxx	923.xx.xxx-xxx	924.xx.xxx-xxx	925.xx.xxx-xxx
dia.h6 [mm]	L [mm]	article no.	article no.	article no.	article no.
6,0	58,0	922.xx.060-058	923.xx.060-058	924.xx.060-058	925.xx.060-058
6,0	76,5	922.xx.060-076	923.xx.060-076	924.xx.060-076	925.xx.060-076
8,0	64,2	922.xx.080-064	923.xx.080-064	924.xx.080-064	925.xx.080-064
8,0	101,2	922.xx.080-101	923.xx.080-101	924.xx.080-101	925.xx.080-101
10,0	67,2	922.xx.100-067	923.xx.100-067	924.xx.100-067	925.xx.100-067
10,0	73,2	922.xx.100-073	923.xx.100-073	924.xx.100-073	925.xx.100-073
10,0	101,2	922.xx.100-101	923.xx.100-101	924.xx.100-101	925.xx.100-101
12,0	74,2	922.xx.120-074	923.xx.120-074	924.xx.120-074	925.xx.120-074
12,0	84,2	922.xx.120-084	923.xx.120-084	924.xx.120-084	925.xx.120-084
12,0	101,1	922.xx.120-101	923.xx.120-101	924.xx.120-101	925.xx.120-101
14,0	84,2	922.xx.140-084	923.xx.140-084	924.xx.140-084	925.xx.140-084
14,0	101,2	922.xx.140-101	923.xx.140-101	924.xx.140-101	925.xx.140-101
16,0	83,2	922.xx.160-083	923.xx.160-083	924.xx.160-083	925.xx.160-083
16,0	93,2	922.xx.160-093	923.xx.160-093	924.xx.160-093	925.xx.160-093
16,0	101,2	922.xx.160-101	923.xx.160-101	924.xx.160-101	925.xx.160-101
18,0	93,0	922.xx.180-093	923.xx.180-093	924.xx.180-093	925.xx.180-093
18,0	102,0	922.xx.180-102	923.xx.180-102	924.xx.180-102	925.xx.180-102
18,0	151,3	922.xx.180-151	923.xx.180-151	924.xx.180-151	925.xx.180-151
20,0	93,2	922.xx.200-093	923.xx.200-093	924.xx.200-093	925.xx.200-093
20,0	105,0	922.xx.200-105	923.xx.200-105	924.xx.200-105	925.xx.200-105
20,0	151,2	922.xx.200-151	923.xx.200-151	924.xx.200-151	925.xx.200-151
25,0	122,0	922.xx.250-122	923.xx.250-122	924.xx.250-122	925.xx.250-122
25,0	152,0	922.xx.250-152	923.xx.250-152	924.xx.250-152	925.xx.250-152



	preforming				
	design				

	DIN 332 center				
	Form A	Form R	others		
	1 x 2,12	1 x 2,12			
	1,25 x 2,65	1,25 x 2,65			
	1,6 x 3,35	1,6 x 3,35			
	2 x 4,25	2 x 4,25			
	2,5 x 5,3	2,5 x 5,3			
	3,15 x 6,7	3,15 x 6,7			

	coolant connection				
	design				

	flutes				
	design	numbers			

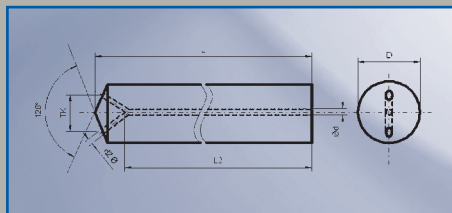
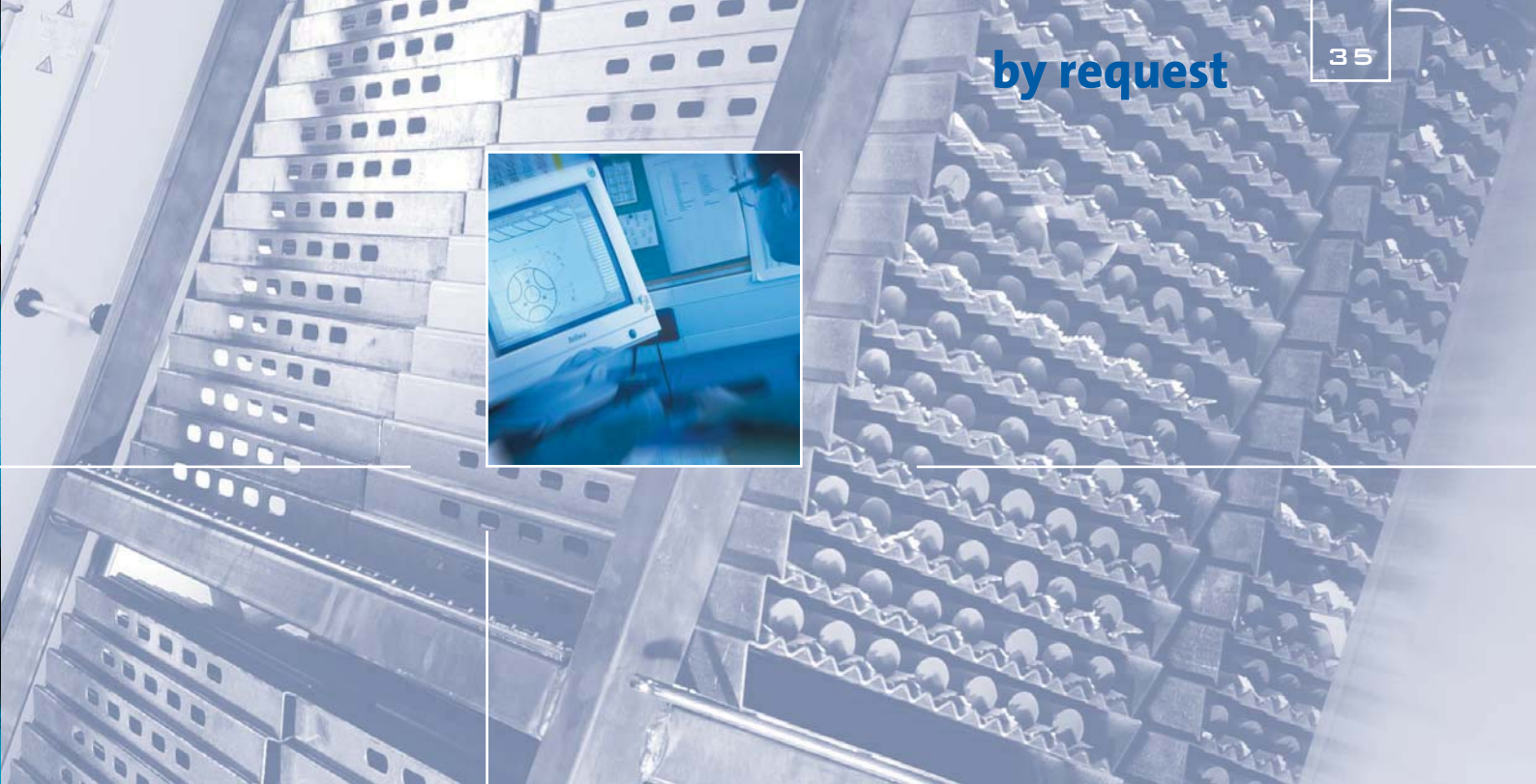

Y-holes			
angle	hole spacing	hole diameter	

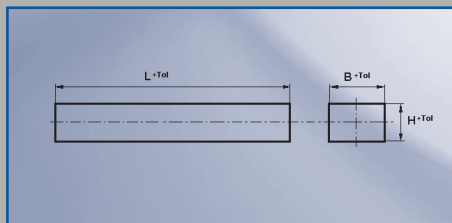

square rods					
B [mm]	+Tol	H [mm]	+Tol	L [mm]	+Tol
<b>4,4</b>	+0,2	<b>4,4</b>	+0,2	<b>330</b>	+10
...	...	...	...	...	...
...	...	...	...	...	...
<b>20,4</b>	+0,2	<b>20,4</b>	+0,2	<b>330</b>	+10

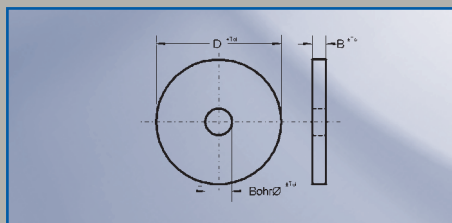

disks					
dia.[mm]	+Tol	B [mm]	+Tol	dØ [mm]	-Tol
<b>50</b>	+0,5	<b>1</b>	+0,4	<b>15,5</b>	-0,4
...	...	...	...	...	...
...	...	...	...	...	...
<b>200</b>	+1	<b>15</b>	+0,6	<b>31,5</b>	-0,6

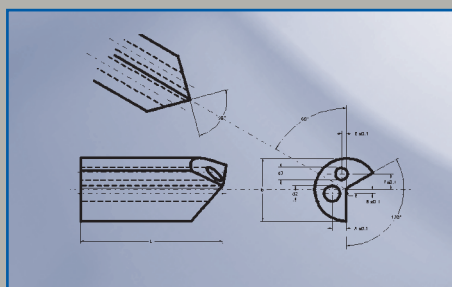

gun drill heads							
dia.[mm]	+Tol	L [mm]	+Tol	dØ 2 [mm]	±Tol	dØ 3 [mm]	±Tol
<b>4,3</b>	+0,3	<b>35</b>	+0,4	<b>0,8</b>	±0,2	<b>0,6</b>	±0,2
...	...	...	...	...	...	...	...
...	...	...	...	...	...	...	...
<b>33,3</b>	+0,5	<b>65</b>	+1	<b>7,5</b>	±0,4	<b>6,5</b>	±0,4



## Kulmbach/Mainleus

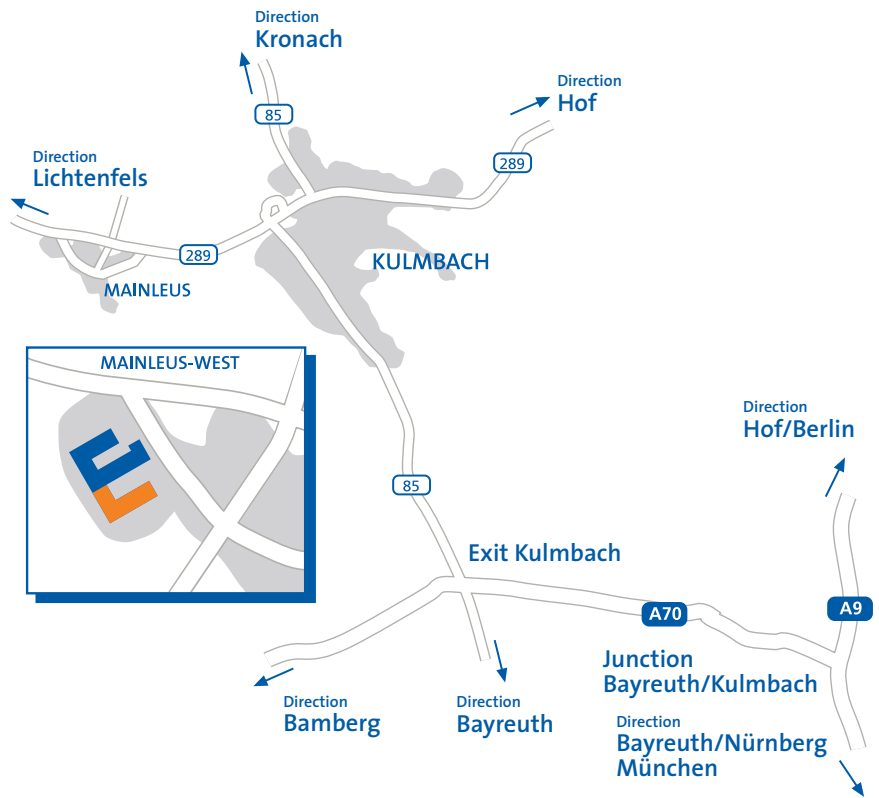

**Arno Friedrichs Hartmetall GmbH Co. KG**

Burgkunstadter Str. 7  
 95336 Mainleus · Germany  
 Phone: +49 (92 29) 96 47 - 0  
 Fax: +49 (92 29) 96 47 - 11  
 e-mail: [service@afcarbide.com](mailto:service@afcarbide.com)  
[www.afcarbide.com](http://www.afcarbide.com)