

ОБОЗНАЧЕНИЕ

(mm)

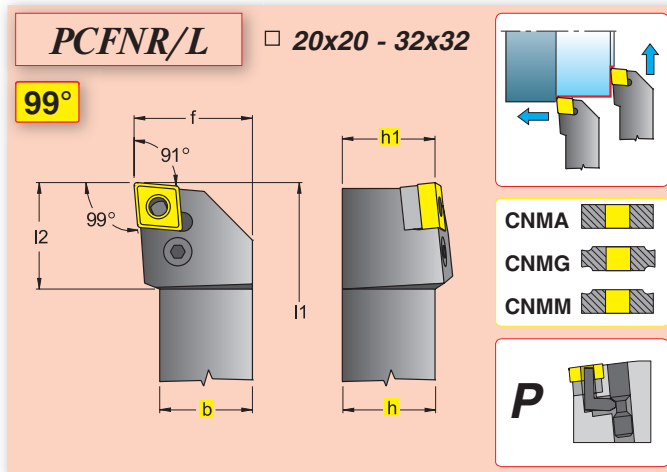

	h=h1	b	f	l1	l2	
PCLNR/L 1616 H 09	16	16	20	100	22	0903
PCLNR/L 2020 K 09	20	20	25	125	26	
PCLNR/L 2525 M 09	25	25	32	150	25	
PCLNR/L 1616 H 09T3	16	16	20	100	22	09T3
PCLNR/L 2020 K 09T3	20	20	25	125	26	
PCLNR/L 2525 M 09T3	25	25	32	150	25	
PCLNR/L 2020 K 12	20	20	25	125	28	1204
PCLNR/L 2525 M 12	25	25	32	150	33	
PCLNR/L 3225 P 12	32	25	32	170	28	
PCLNR/L 3232 P 12	32	32	40	170	30	
PCLNR/L 2525 M 16	25	25	32	150	33	1606
PCLNR/L 3225 P 16	32	25	32	170	33	
PCLNR/L 3232 P 16	32	32	40	170	33	
PCLNR/L 2525 M 19	25	25	32	150	36	1906
PCLNR/L 3225 P 19	32	25	32	170	40	
PCLNR/L 3232 P 19	32	32	40	170	40	
PCLNR/L 4040 S 19	40	40	50	250	48	
PCLNR/L 4040 S 25	40	40	50	250	48	
PCLNR/L 5050 T 25	50	50	60	300	48	2509



ОБОЗНАЧЕНИЕ	(mm)							
	R	L	h=h1	b	f		l1	l2
PCFNR/L 2020 K 12			20	20	25	125	30	1204
PCFNR/L 2525 M 12			25	25	32	150	30	
PCFNR/L 3225 P 16			32	25	32	170	39	1606
PCFNR/L 3232 P 19			32	32	40	170	39	1906

PCBNR/L □ 20x20 - 50x50

75°

CNMA
CNMG
CNMM

P

ОБОЗНАЧЕНИЕ		(mm)							
R	L	h=h1	b	f	l1	l2			
PCBNR/L	2020	K	12	20	20	17	125	28	1204
PCBNR/L	2525	M	12	25	25	22	150	29	
PCBNR/L	3225	P	12	32	25	22	170	32	
PCBNR/L	2525	M	16	25	25	22	150	29	1606
PCBNR/L	3225	P	16	32	25	22	170	32	
PCBNR/L	3232	P	16	32	32	27	170	35	1906
PCBNR/L	3232	P	19	32	32	27	170	35	
PCBNR/L	4040	S	19	40	40	35	250	37	2509
PCBNR/L	4040	S	25	40	40	35	250	48	
PCBNR/L	5050	T	25	50	50	60	300	47	

PCKNR/L □ 20x20 - 40x40

75°

CNMA
CNMG
CNMM

P

ОБОЗНАЧЕНИЕ		(mm)							
R	L	h=h1	b	f	l1	l2			
PCKNR/L	2020	K	12	20	20	25	125	26	1204
PCKNR/L	2525	M	12	25	25	32	150	25	
PCKNR/L	3225	P	12	32	25	32	170	26	
PCKNR/L	3232	P	19	32	32	40	170	36	1906
PCKNR/L	4040	S	19	40	40	50	250	45	

PCSNR/L

□ 20x20 - 40x40

45°

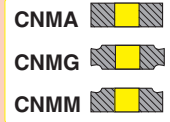
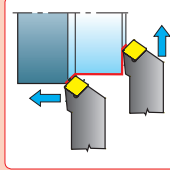
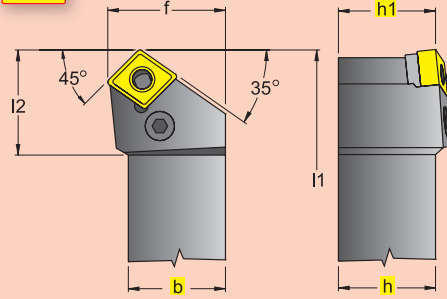

ОБОЗНАЧЕНИЕ

(mm)

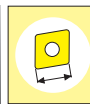

h=h1 b f l1 l2

PCSNR/L 2020 K 12	20	20	25	125	28	1204
PCSNR/L 2525 M 12	25	25	32	150	30	
PCSNR/L 2525 M 16	25	25	32	150	30	1606
PCSNR/L 3225 P 16	32	25	32	170	39	
PCSNR/L 3225 P 19	32	25	32	170	39	1906
PCSNR/L 3232 P 19	32	32	40	170	39	
PCSNR/L 4040 S 19	40	40	50	250	48	

PDJNR/L

□ 16x16 - 50x50

93°

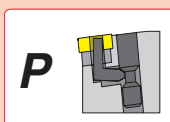
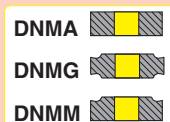
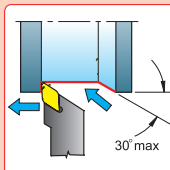
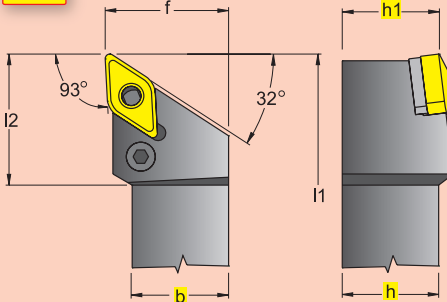

ОБОЗНАЧЕНИЕ

(mm)

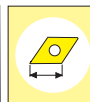

h=h1 b f l1 l2

PDJNR/L 1616 H 11	16	16	20	100	30	1104
PDJNR/L 2020 K 11	20	20	25	125	30	
PDJNR/L 2525 M 11	25	25	32	150	30	
PDJNR/L 2020 K 15	20	20	25	125	35	1506
PDJNR/L 2525 M 15	25	25	32	150	35	
PDJNR/L 3225 P 15	32	25	32	170	35	
PDJNR/L 3232 P 15	32	32	40	170	36	
PDJNR/L 2020 K 1504	20	20	25	125	35	1504
PDJNR/L 2525 M 1504	25	25	32	150	35	
PDJNR/L 3225 P 1504	32	25	32	170	35	
PDJNR/L 3232 P 1504	32	32	40	170	36	
PDJNR/L 4040 S 15	40	40	32	250	48	1506
PDJNR/L 5050 T 15	50	50	40	300	48	

PDNNR/L □ 20x20 - 40x32

63°

DNMA
 DNMG
 DNMM

P

ОБОЗНАЧЕНИЕ		(mm)					
R	L	h=h1	b	f	l1	l2	
PDNNR/L	2020 K 15	20	20	12,0	125	35	1506
PDNNR/L	2525 M 15	25	25	12,0	150	37	
PDNNR/L	3225 P 15	32	25	12,0	170	37	
PDNNR/L	3232 P 15	32	32	16,8	170	37	1504
PDNNR/L	2020 K 1504	20	20	12,0	125	35	
PDNNR/L	2525 M 1504	25	25	12,0	150	37	
PDNNR/L	3225 P 1504	32	25	12,0	170	37	
PDNNR/L	3232 P 1504	32	32	16,8	170	37	
PDNNR/L	4032 P 15	40	32	18	170	40	

PSBNR/L □ 20x20 - 50x50

75°

SNMA
 SNMG
 SNMM

P

ОБОЗНАЧЕНИЕ		(mm)					
R	L	h=h1	b	f	l1	l2	
PSBNR/L	2020 K 12	20	20	17	125	28	1204
PSBNR/L	2525 M 12	25	25	22	150	29	1506
PSBNR/L	3225 P 12	32	25	22	170	27	
PSBNR/L	2525 M 15	25	25	22	150	32	
PSBNR/L	3232 P 15	32	32	27	170	32	1906
PSBNR/L	3232 P 19	32	32	27	170	39	
PSBNR/L	4040 S 19	40	40	35	250	39	2507
PSBNR/L	4040 S 25	40	40	35	250	39	
PSBNR/L	5050 T 25	50	50	43	300	48	

PSDNN □ 16x16 - 40x40

45°

SNMA
 SNMG
 SNMM

P

ОБОЗНАЧЕНИЕ		(mm)					
		h=h1	b	f	l1	l2	
PSDNN	1616 H 09	16	16	8,3	100	26	0903
PSDNN	2020 K 12	20	20	10,3	125	28	1204
PSDNN	2525 M 12	25	25	12,8	150	29	
PSDNN	3232 P 19	32	32	16,5	170	40	1906
PSDNN	3225 P 19	32	25	12,8	170	39	
PSDNN	3232 P 19	32	32	16,5	170	39	
PSDNN	4040 S 25	40	40	21	250	48	2507

PSKNR/L □ 20x20 - 50x50

75°

SNMA
 SNMG
 SNMM

P

ОБОЗНАЧЕНИЕ		(mm)					
		h=h1	b	f	l1	l2	
PSKNR/L	2020 K 12	20	20	25	125	26	1204
PSKNR/L	2525 M 12	25	25	32	150	26	
PSKNR/L	3225 P 12	32	25	32	170	26	
PSKNR/L	2525 M 15	25	25	32	150	30	1506
PSKNR/L	3232 P 15	32	32	40	170	30	
PSKNR/L	3232 P 19	32	32	40	170	34	1906
PSKNR/L	4040 S 19	40	40	50	250	38	
PSKNR/L	4040 S 25	40	40	50	250	38	2507
PSKNR/L	5050 T 25	50	50	43	300	50	

PSSNR/L □ 20x20 - 40x40

45°

SNMA
SNMG
SNMM

P

ОБОЗНАЧЕНИЕ		(mm)					
		h=h1	b	f	l1	l2	
PSSNR/L 2020	K 12	20	20	25	125	29	1204
PSSNR/L 2525	M 12	25	25	32	150	29	
PSSNR/L 3225	P 12	32	25	32	170	29	
PSSNR/L 2525	M 15	25	25	32	150	35	1506
PSSNR/L 3232	P 15	32	32	40	170	36	
PSSNR/L 3232	P 19	32	32	40	170	40	1906
PSSNR/L 4040	S 19	40	40	50	250	40	

PRGNR/L □ 20x20 - 40x40

45°

RNMA
RNMG
RNMM

P

ОБОЗНАЧЕНИЕ		(mm)					
		h=h1	b	f	l1	l2	
PRGNR/L 2020	K 09	20	20	25	125	30	0903
PRGNR/L 2020	K 12	20	20	32	125	30	1204
PRGNR/L 2525	M 12	25	25	32	150	30	
PRGNR/L 3225	P 15	32	25	32	170	39	1506
PRGNR/L 3232	P 19	32	32	40	170	39	1906
PRGNR/L 4040	S 25	40	40	50	250	48	2509

PRDCN

□ 20x20 - 40x40

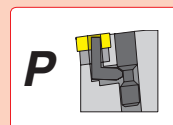
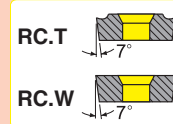
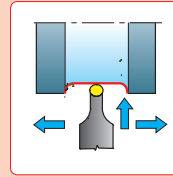
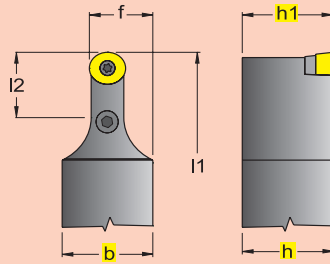

ОБОЗНАЧЕНИЕ

(mm)



		h=h1	b	f	l1	l2	
PRDCN	2020 K 10	20	20	15	125	30	1003
PRDCN	2020 K 12	20	20	16	125	30	1204
PRDCN	2525 M 12	25	25	18,5	150	30	
PRDCN	3225 P 12	32	25	18,5	170	39	
PRDCN	2525 M 16	25	25	20,5	150	30	1606
PRDCN	3225 P 16	32	25	20,5	170	39	
PRDCN	3232 P 16	32	32	24	170	39	
PRDCN	3232 P 20	32	32	26	170	39	2006
PRDCN	4040 S 25	40	40	32,5	250	48	2507

PRGCR/L

□ 20x20 - 50x50

60°

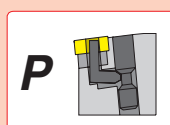
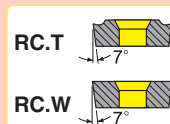
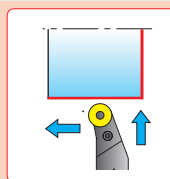
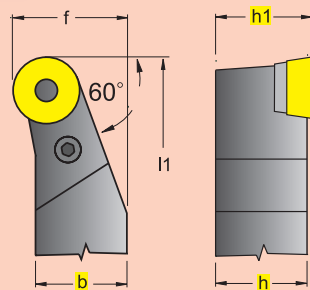

ОБОЗНАЧЕНИЕ

(mm)

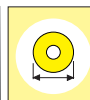

		h=h1	b	f	l1	l2	
PRGCR/L	2020 K 10	20	20	25	125	-	1003
PRGCR/L	2020 K 12	20	20	25	125	-	1204
PRGCR/L	2525 M 12	25	25	32	150	-	
PRGCR/L	2525 M 16	25	25	32	150	-	1606
PRGCR/L	3225 P 16	32	25	32	170	-	
PRGCR/L	3232 P 20	32	32	40	170	-	2006
PRGCR/L	4040 S 25	40	40	50	250	-	2507
PRGCR/L	5050 T 32	50	50	63	300	-	3209

PWLNR/L □ 16x16 - 32x32

95°

WNMA
 WNMG
 WNMM

P

ОБОЗНАЧЕНИЕ		(mm)					
R	L	h=h1	b	f	l1	l2	
		16	16	20	100	16	0604
		20	20	25	125	16	
		25	25	32	150	16	
		16	16	20	100	16	06T3
		20	20	25	125	16	
		25	25	32	150	16	
		20	20	25	125	20	0804
		25	25	32	150	21	
		32	25	32	170	23	
		32	32	40	170	23	

PTFNR/L □ 20x20 - 40x40

90°

TNMA
 TNGA
 TNMG
 TNMM

P

ОБОЗНАЧЕНИЕ		(mm)					
R	L	h=h1	b	f	l1	l2	
		20	20	25	125	20	1604
		25	25	32	150	21	
		32	25	32	170	22	
		25	25	32	150	27	2204
		32	25	32	170	25	
		32	32	40	170	25	
		32	32	40	170	39	2706
		40	40	50	250	48	

PTGNR/L □ 20x20 - 40x40

90°

TNMA

TNMG

TNMM

P

ОБОЗНАЧЕНИЕ 	(mm)					
	h=h1	b	f	l1	l2	
PTGNR/L 2020 K 16	20	20	25	125	20	1604
PTGNR/L 2525 M 16	25	25	32	150	21	
PTGNR/L 3225 P 16	32	25	32	170	22	2204
PTGNR/L 2525 M 22	25	25	32	150	27	
PTGNR/L 3225 P 22	32	25	32	170	29	2706
PTGNR/L 3232 P 22	32	32	40	170	29	
PTGNR/L 3232 P 27	32	32	40	170	39	2706
PTGNR/L 4040 S 27	40	40	50	250	48	

PTTNR/L □ 20x20 - 25x25

60°

TNMA

TNMG

TNMM

P

ОБОЗНАЧЕНИЕ 	(mm)					
	h=h1	b	f	l1	l2	
PTTNR/L 2020 K 16	20	20	17	125	30	1604
PTTNR/L 2525 M 16	25	25	22	150	30	
PTTNR/L 2525 M 22	25	25	22	150	30	2204

PTDNR/L □ 20x20 - 25x25

45°

TNMA
TNMG
TNMM

P

ОБОЗНАЧЕНИЕ 	(mm)					
	h=h1	b	f	l1	l2	
PTDNR/L 2020 K 16	20	20	22	125	30	1604
PTDNR/L 2525 M 16	25	25	27	150	30	
PTDNR/L 2525 M 22	25	25	27	150	30	2204

MSKNR/L □ 20x20 - 25x25

75°

SNMA
SNMG

P

ОБОЗНАЧЕНИЕ 	(mm)					
	h=h1	b	f	l1	l2	
MSKNR/L 2020 K 12	20	20	25	125	30	1204
MSKNR/L 2525 M 12	25	25	32	150	30	