

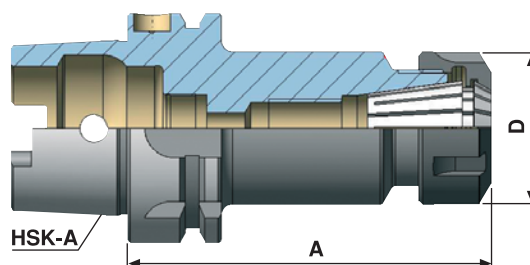

Номер по каталогу	HSK-A	Диапазон зажимаемых диаметров d, мм	Диапазон зажимаемых диаметров d, мм	
			A	D
A32.02.10	HSK-A 32	ER16 1 - 10	80	32
A32.02.16	HSK-A 32	ER25 2 - 16	80	42
A40.02.10	HSK-A 40	ER16 1 - 10	80	32
A40.02.16	HSK-A 40	ER25 2 - 16	80	42
A40.02.20	HSK-A 40	ER32 2 - 20	100	50
A50.02.10	HSK-A 50	ER16 1 - 10	100	32
A50.02.16	HSK-A 50	ER25 2 - 16	100	42
A50.02.20	HSK-A 50	ER32 2 - 20	100	50
A63.02.10	HSK-A 63	ER16 1 - 10	100	32
A63.02.10.2	HSK-A 63	ER16 1 - 10	160	32
A63.02.16	HSK-A 63	ER25 2 - 16	100	42
A63.02.16.2	HSK-A 63	ER25 2 - 16	160	42
A63.02.20	HSK-A 63	ER32 2 - 20	100	50
A63.02.20.2	HSK-A 63	ER32 2 - 20	160	50
A63.02.26	HSK-A 63	ER40 3 - 26	120	63
A63.02.26.2	HSK-A 63	ER40 3 - 26	160	63
A80.02.20	HSK-A 80	ER32 2 - 20	100	50
A80.02.26	HSK-A 80	ER40 3 - 26	120	63
A100.02.16	HSK-A 100	ER25 2 - 16	100	42
A100.02.20	HSK-A 100	ER32 2 - 20	100	50
A100.02.26	HSK-A 100	ER40 3 - 26	120	63



В комплект входит: гайка

#### Комплектующие

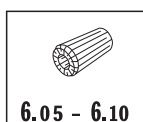

Цанги ER

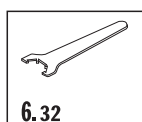

Ключ ER



## под цанги типа ER по DIN 6499

Номер по каталогу	HSK-C	Диапазон зажимаемых диаметров d, мм	A	D
C32.02.10	HSK-C 32	ER16 1-10	60	32
C40.02.10	HSK-C 40	ER16 1-10	60	32
C40.02.16	HSK-C 40	ER25 2-16	70	42
C40.02.20	HSK-C 40	ER32 2-20	75	50
C50.02.10	HSK-C 50	ER16 1-10	60	32
C50.02.16	HSK-C 50	ER25 2-16	70	42
C50.02.20	HSK-C 50	ER32 2-20	75	50
C50.02.26	HSK-C 50	ER40 3-26	80	63
C63.02.16	HSK-C 63	ER25 2-16	70	42
C63.02.20	HSK-C 63	ER32 2-20	75	50
C63.02.26	HSK-C 63	ER40 3-26	80	63

В комплект входит: гайка

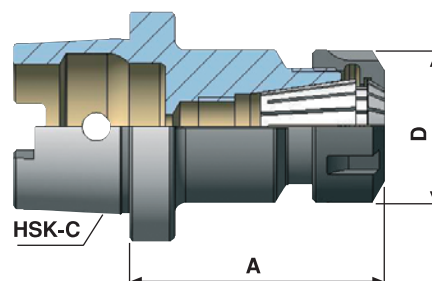

## Комплектующие

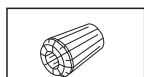

6.05 - 6.10

Цанги ER

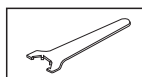

6.32

Ключ ER



## под цанги типа ER по DIN 6499

Номер по каталогу	HSK-E	Диапазон зажимаемых диаметров d, мм	A	D	SW
E32.02.10	HSK-E 32	ER16 1-10	60	32	22
E32.02.16	HSK-E 32	ER25 2-16	80	42	27
E40.02.10	HSK-E 40	ER16 1-10	60	32	22
E40.02.16	HSK-E 40	ER25 2-16	70	42	27
E50.02.10	HSK-E 50	ER16 1-10	100	32	22
E50.02.16	HSK-E 50	ER25 2-16	70	42	27
E50.02.20	HSK-E 50	ER32 2-20	80	50	34
E50.02.26	HSK-E 50	ER40 3-26	100	63	46
E63.02.20	HSK-E 63	ER32 2-20	75	50	34
E63.02.26	HSK-E 63	ER40 3-26	80	63	46

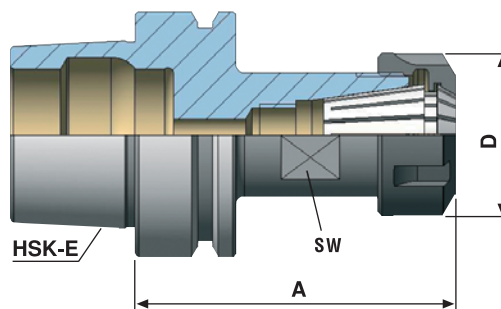

В комплект входит: гайка  
Отбалансирован по G 2,5 20000 min<sup>-1</sup>

## Комплектующие



6.05 - 6.10

Цанги ER

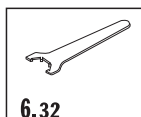

6.32

Ключ ER