

Tube Scarfing

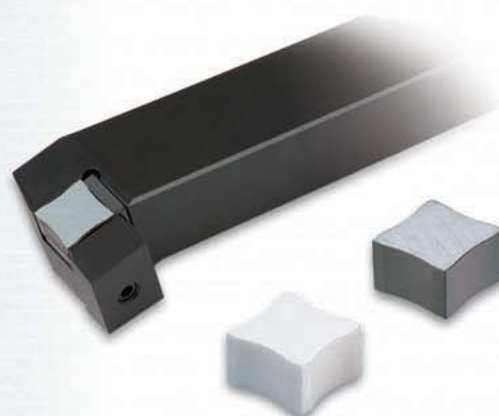
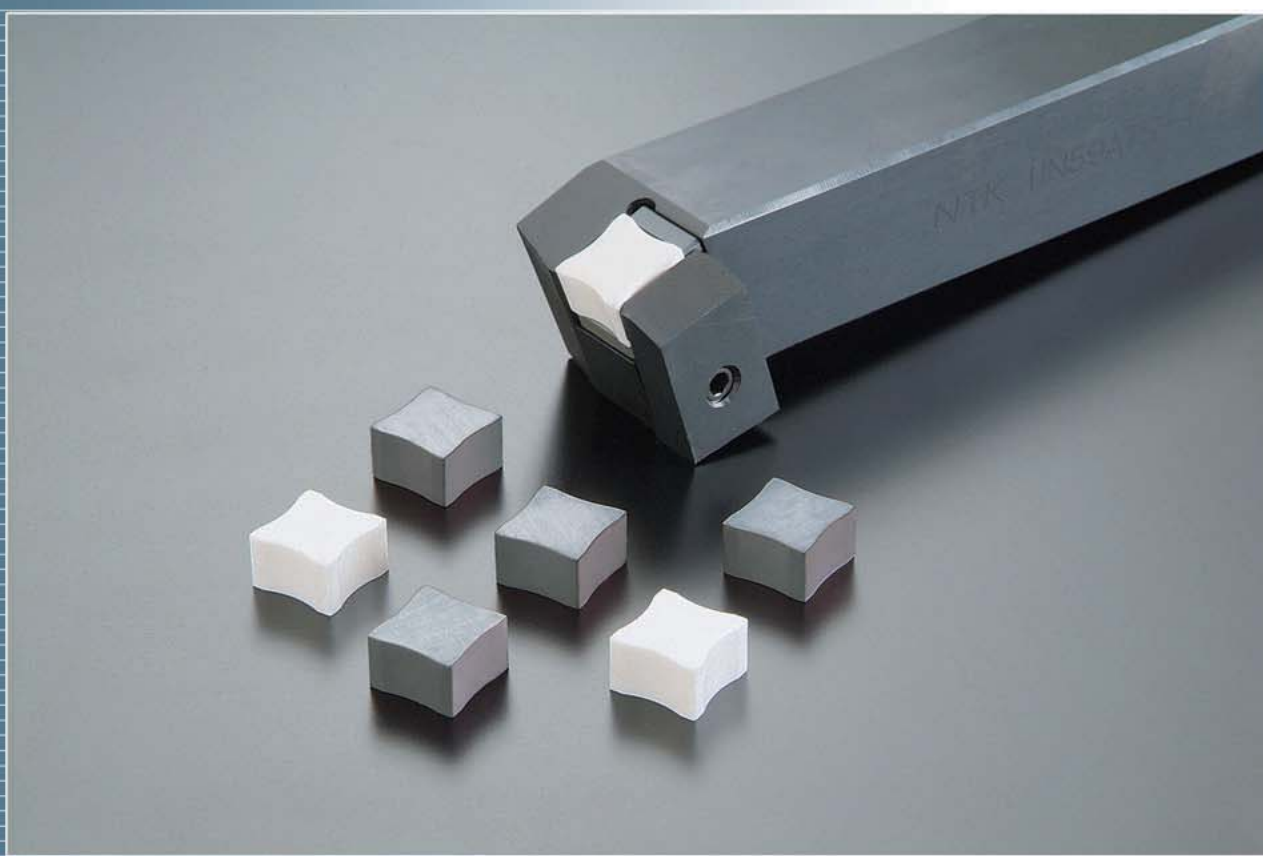

Tube scarfing

ATS

(HN59ATS type [Right hand] · HN60ATS type [Left hand])

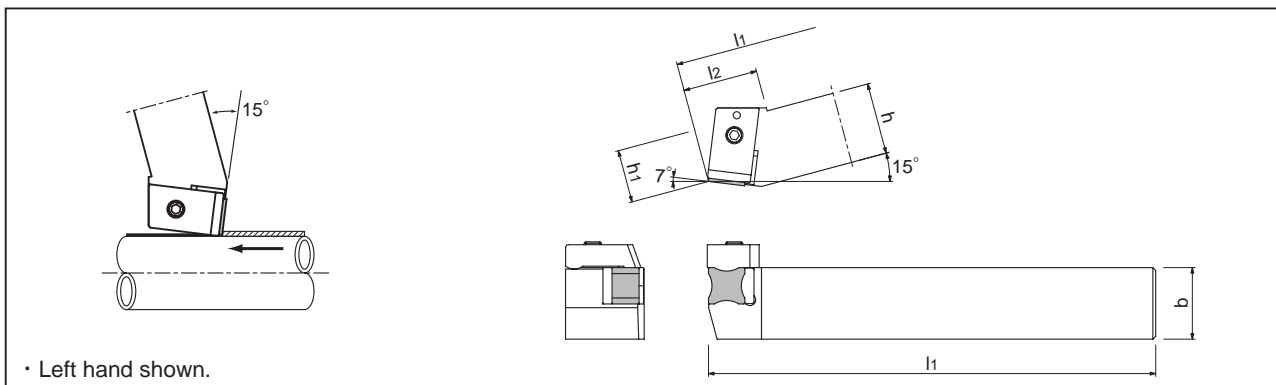



Toolholder	Stock		Dimensions (mm)					Insert	
	R(59)	L(60)	h	b	l1	h1	l2		
HN ^{60/59} ATS-33E			19	19	160	12.5	26		TSN45
ATS-44E	●	●	25	25	160	18.5	26		TSN55
ATS-44E-5			25	25	160	18.5	26		

For details of insert, see next page.

BTS

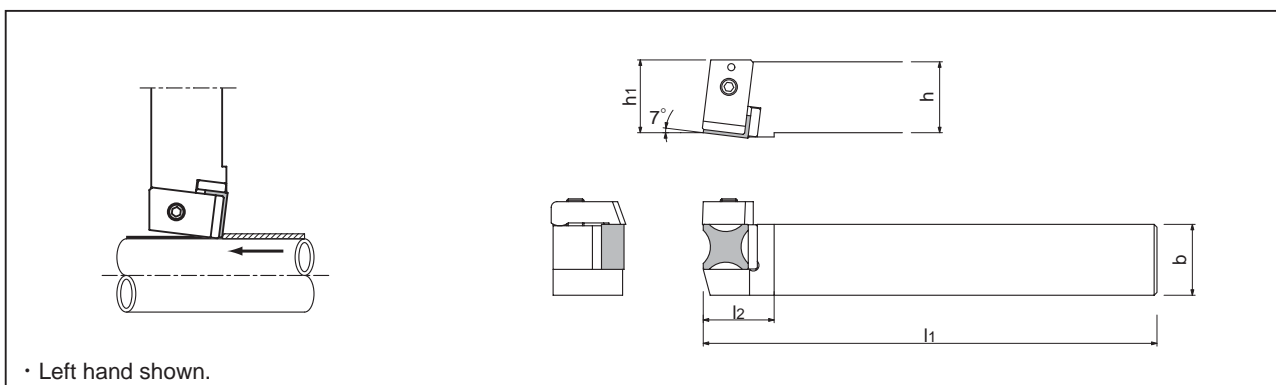
(HN59BTS type [Right hand] · HN60BTS type [Left hand])



Toolholder	Stock		Dimensions (mm)					Insert	
	R(59)	L(60)	h	b	l1	h1	l2		
HN ^{60/59} BTS-33E			19	19	160	19	25		TSN45
BTS-44E		●	25	25	160	25	25		TSN55
BTS-44E-5			25	25	160	25	25		

● Insert

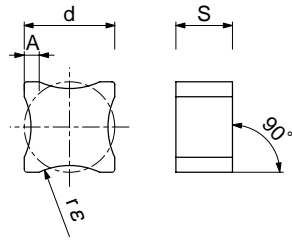

Insert Number	Dimensions (mm)				Ceramic	Cermet
	r ε	A	d	S	CX3*	N20
TSN 45-8 45-10 45-12 45-14 45-16 45-18 45-20 45-25 45-30 45-35 45-40 45-50 45-60 45-70 45-90	8	2.10	12.70	7.94		
	10					
	12					
	14					
	16					
	18					
	20					
	25					
	30					
	35					
	40					
	50					
	60					
	70					
	90					
TSN 55-12 55-15 55-20 55-25 55-30 55-35 55-40 55-45 55-70 55-100	12	32.0	15.875	7.94		
	15					
	20					
	25					
	30					
	35					
	40					
	45					
	70					
	100					

* The CX3 is an alumina-based ceramic like HC1.

● Parts

Parts	Clamp	Clamping screw	Shim	Shim screw	Wrench
Toolholder					
HN ⁶⁰ / ₅₉ ATS-33E ATS44E	HC ⁶⁰ / ₅₉ TS-4	WS0620	ASN423	M3×5.5	LW-3
ATS44E-5			AZT659D	M3×8	
			ASN522	M3×8	
HN ⁶⁰ / ₅₉ BTS-33E BTS-44E			HAZT1255A	M4×5.5	
			ASN423	M3×5.5	
BTS-44E-5	AZT659D	M3×8			
	ASN522	M3×8			
			HAZT1255A	M4×5.5	